

TAYLOR STUDWELDING SYSTEMS LIMITED



OPERATING GUIDE

FOR

AUTO SEQUENCER UNIT

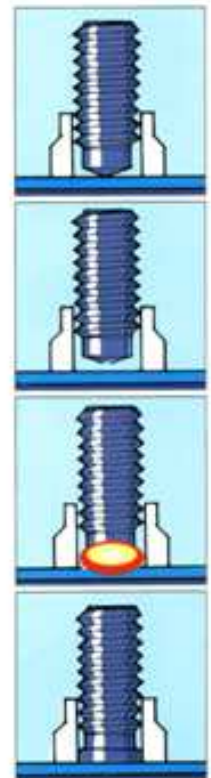

A TAYLORMADE AUTOFEED STUDWELDING SYSTEM FOR CD AND SHORT CYCLE STUDS

INDEX

PAGE	CONTENT
3	General information
5	Introduction
7	External features
9	Safety
12	Setting up & welding - General
21	Setting up & welding - Bowl & escapement
24	Setting up & welding - Weld controller
25	Setting up & welding - Handtool / weld head
26	Setting up & welding - Welding
27	Weld quality
28	Trouble shooting
30	Sequencer component explosion
35	Bowl feeder component explosion
37	Pneumatic diagram
38	Electrical schematic diagrams
44	Control signals
45	Weld sequence
46	EC declaration of conformity

GENERAL INFORMATION



MANUFACTURERS DETAILS

TAYLOR STUDWELDING SYSTEMS LIMITED
COMMERCIAL ROAD
DEWSBURY
WEST YORKSHIRE
WF13 2BD
ENGLAND

TELEPHONE	:	+44 (0)1924 452123
FACSIMILE	:	+44 (0)1924 430059
e-mail	:	info@taylor-studwelding.com
TECHNICAL TEL	:	+44 (0)1924 487703
SALES TEL	:	+44 (0)1924 487701

PURPOSE AND CONTENT OF THIS MANUAL

This manual has been written for :

-  The operator of the welding machine.
-  The personnel of the final customer responsible for the installation and operation of the machine.

This manual contains information on :

-  Installation and connection
-  Operation.
-  Technical data.
-  Spare parts.
-  Accessories.

GENERAL INFORMATION

FURTHER INFORMATION

Should you require additional technical information, please contact us directly (details on page 3) or our local agent / distributor (details of agents etc. can be obtained from us).

This manual contains important information which is a pre-requisite for safe operation of the equipment. The operating personnel must be able to consult this manual. In the interests of safety, make this manual available to your personnel in good time.

If the equipment is sold / passed on, please hand over this manual to the new owner. Please immediately inform us of the name and address of the new owner, in case we need to contact him regarding the safety of the device.



Please read this manual carefully before installation of the machine.



Please especially observe the safety instructions.

INTRODUCTION

INTRODUCTION

The complete range of Taylor Studwelding Systems Capacitor Discharge and Drawn Arc units are compact, portable Stud Welding equipments. The units are specifically designed to enable a small diameter range of ferrous and non-ferrous weld studs to be welded to light gauge, self-finish or pre-coated materials, and in the case of CD with little or no reverse marking.

The equipment consists of an automatic feed welding pistol, bowl feed and sequence unit and the necessary interconnecting cables and accessories (see page 7 for the equipment schedule).

Two different processes are available: Capacitor Discharge (CD) and Drawn Arc (DA), these are outlined below.

THE PROCESS (CD)

Capacitor Discharge stud welding is a form of welding in which the energy required for the welding process is derived from a bank of charged capacitors. This stored energy is discharged across the gap between the two surfaces to be welded as they are propelled towards each other. The arc produced heats the two surfaces, melting a thin film of metal on each surface and the propelling force closes the gap between the two faces, thus forming a weld.

In contact welding the stud to be welded is forced by spring pressure on to the plate. At this point the arc gap between the two components is maintained by a small pip on the welding face of the stud. On initiation of the high current pulse from the capacitors, this pip vaporises and an arc is drawn between the workpiece and the stud. The heat from this arc melts the base of the stud and the area of the work piece directly beneath the stud, whilst the spring pressure from the pistol accelerates the stud towards the workpiece. Within 3 to 4 milliseconds the stud hits the workpiece and the arc is extinguished. The kinetic energy contained in the moving stud and the remaining spring pressure, forge the molten parts together to form a weld.

INTRODUCTION

THE PROCESS (DA)

The Drawn Arc process is a long established, well proven method of stud welding. The pistol lifts the stud to be welded away from the workpiece, simultaneously striking an arc between the two. This causes both the stud and the workpiece to melt. After the pre-selected weld time has elapsed, the pistol returns the stud to the molten pool on the workpiece, thus forming the weld. The energy required to perform the weld is derived from a transformer - rectifier in the weld control unit.

Infinitely variable weld time allows for short cycle welding, with or without inert gas purging.

EXTERNAL FEATURES

FRONT PANEL

- | | | | |
|----|--------------------------|----|---------------------------|
| 1 | Feed Stud Switch | 2 | Toggle Push-rod Switch |
| 3 | LCD * | 4 | Reset Switch/Earth select |
| 5 | Adjust Knob * | 6 | Set switch * |
| 7 | Vibration Speed Control | 8 | Pressure Regulator |
| 9 | Pistol Control Socket | 10 | Pistol Weld Socket |
| 11 | Controller Weld Socket | 12 | Controller Control Socket |
| 13 | Controller Earth Socket | 14 | Weld Earth Socket |
| 15 | Pneumatic shut-off valve | | |

* Only used on stepper weld head systems

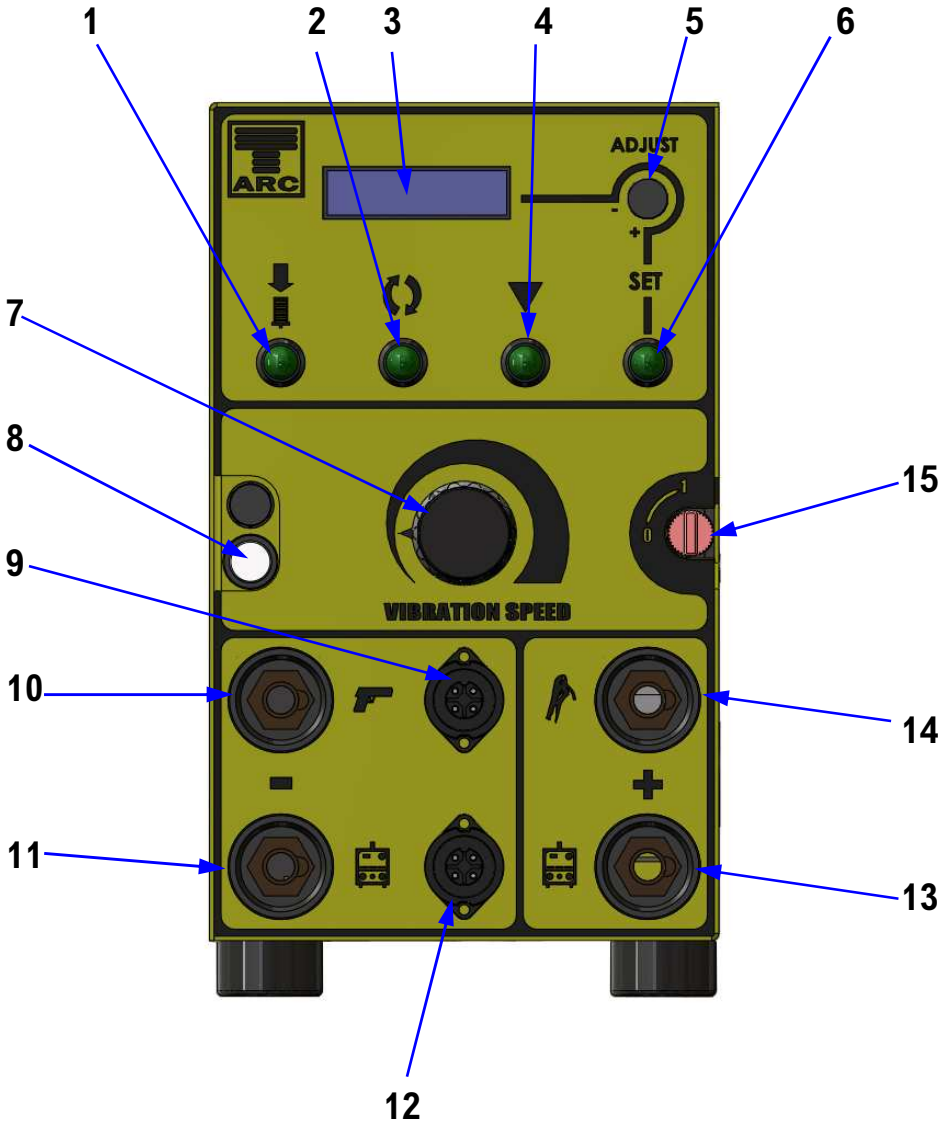

EXTERNAL FEATURES

BACK PANEL

- | | | | |
|---|------------------------------|---|---------------------------------|
| 1 | Pneumatic Inlet | 2 | Fused Mains Inlet |
| 3 | Feed Time Adjustment | 4 | Optional Parameter Adjustment * |
| 5 | Mains Outlet (CD 200 only) | 6 | Weld Head Auxiliary Socket * |
| 7 | External Controller Socket * | 8 | Auxiliary Socket 1 * |
| 9 | Auxiliary Socket 2 * | | |

* Configuration of these items depends on system specification

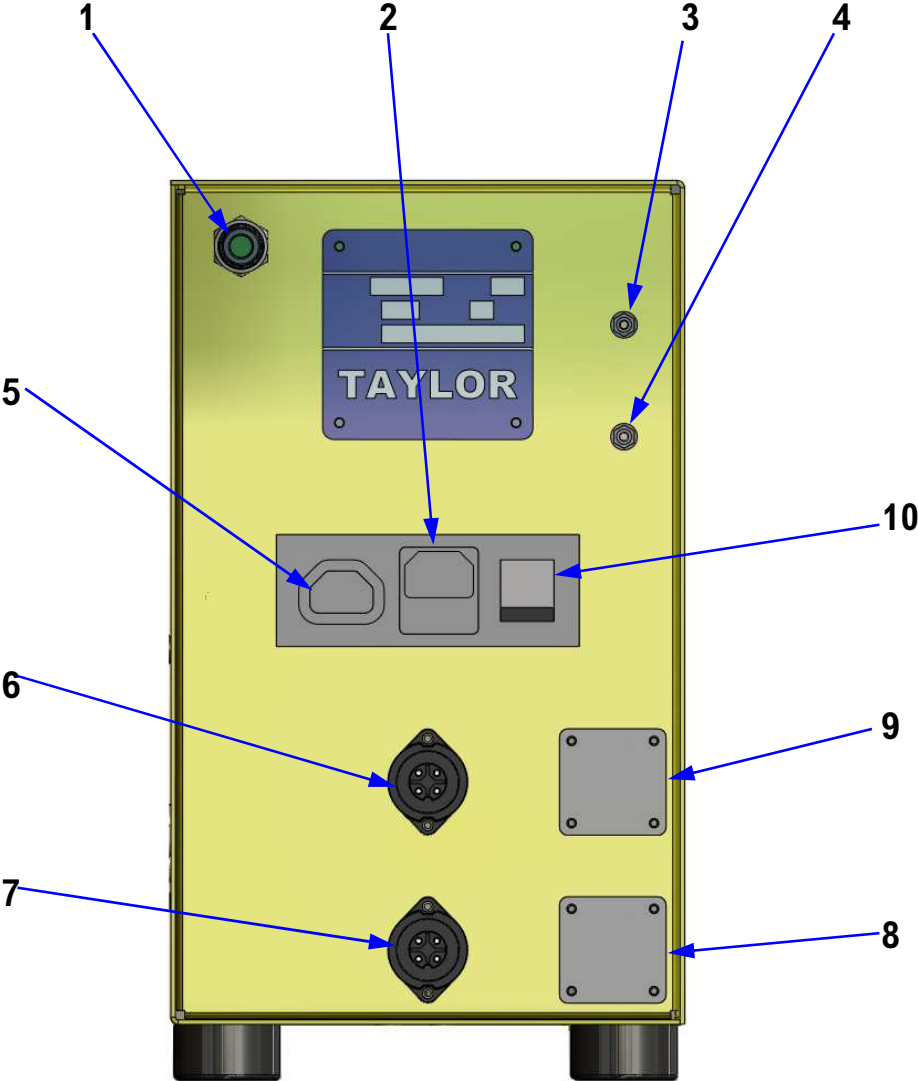

SAFETY

PROTECT YOURSELF AND OTHERS !

Read and understand these safety notices.

1. ELECTRICAL

No portion of the outer cover of the welding controller should be removed by anyone other than suitably qualified personnel and never whilst mains power is connected. **ALWAYS** disconnect the mains plug from the socket.



RISK TO LIFE !!!

BE AWARE ! The CD equipment may contain a sealed power supply module which operates on high frequency inverter principles. Due to the potentially fatal voltages in this module we do not recommend tampering with the module. It can be safely removed and replaced via our factory exchange system.

BE AWARE ! Capacitors store electrical energy. Check for residual charge before carrying out any internal maintenance.

DO NOT ! use any fluids to clean electrical components as these may penetrate into the electrical system

Installation must be according to the setting up procedure detailed on pages 12 to 25 of this manual and must be in line with national, regional and local safety codes.

2. FIRE

During welding small particles of very hot metal are expelled. Ensure that no combustible materials can be ignited by these.

SAFETY

3. PERSONNEL SAFETY

Arc rays can burn your eyes and skin and noise can damage your hearing.

Operators and personnel working in close proximity must wear suitable eye, ear and body protection.

Fumes and gases can seriously harm your health. Use the equipment only in a suitably ventilated area. If ventilation is inadequate, then appropriate fume extraction equipment must be used.

Hot metal spatter can cause fire and burns. Appropriate clothing must be worn.

Clothing made from, or soiled with, combustible materials must NOT be worn. Have a fire extinguisher nearby and know how to use it.

Magnetic fields from high currents can affect heart pacemakers or other electronically controlled medical devices. It is imperative that all personnel likely to come into the vicinity of any welding plant are warned of the possible RISK TO LIFE before entering the area.

4. MAINTENANCE

All cables must be inspected regularly to ensure that no danger exists from worn or damaged insulation or from unsound electrical connections. Special note should be made of the cables close to the pistol, where maximum wear occurs.

As well as producing inconsistent welds, worn cables can overheat or spark, giving rise to the risk of fire.

5. TRAINING

Use of the equipment must be limited to authorised personnel only who must be suitably trained and must have read and understood this manual. This manual must be made available to all operators at all times. Further copies of this manual may be purchased from the manufacturer. Measures must be taken to prevent the use of this equipment by unauthorised personnel.

SAFETY

6. INSTALLATION

Ensure that the site chosen for the equipment is able to support the weight of the equipment and that it will not fall or cause a danger in the course of its normal operation. Do not hang connecting cables over sharp edges and do not install connecting cables near heat sources or via traffic routes where people may trip over them or they may be damaged by the passage of vehicles (forklifts etc.).

7. INTERFERENCE

During welding operations, intense magnetic and electrical fields are unavoidably produced and these may interfere with other sensitive electronic equipment.

All Taylor Studwelding equipment is designed, manufactured and tested to conform the current appropriate European standards and directives regarding electromagnetic emissions and immunity and as such is safe to use in any normal environment.

8. DISPOSAL

The equipment either wholly or any of its component parts may be disposed of as part of general industrial waste or passed to a scrap merchant. Non of the components used in the manufacture are toxic, carcinogenic or harmful to health.

SETTING UP & WELDING

SETTING UP & WELDING

Set up the control unit at the place of work, ensuring that the mains switch is in the OFF position. Ensure that this is done in line with the notes and safety recommendations on pages 10 to 12 of this manual.

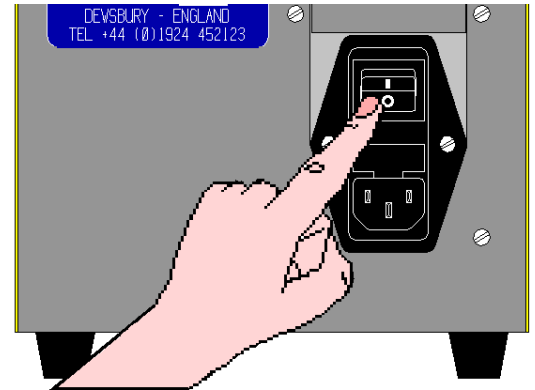

For CD systems plug the CD controller into the IEC outlet at the back of the bowl feed unit.

For DA systems plug the DA controller into the 3 phase AC mains supply.

Plug the bowl feed unit into the mains AC supply using the appropriate IEC lead.

Check the serial plate of the respective units to make sure that the supply voltages are compatible.

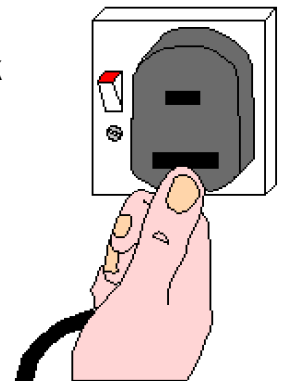

Connect the weld earth link cable between the bowl feed unit and the weld controller. Connect the welding earth cables to the bowl feed unit. Note that the cable end sockets have a key slot to match with the peg on the panel mounted weld plugs.

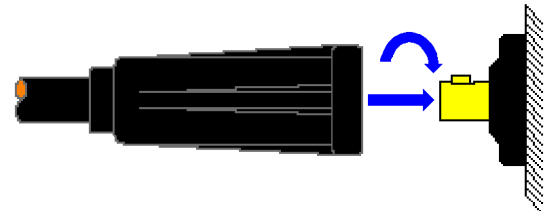

IMPORTANT! Secure the connectors with a clockwise turn until they lock. Failure to do this will result in damage to the connectors during welding.

Attach the welding earth clamps to the work piece at approximately 180° to each other. This will help to prevent "Arc blow" when the welding takes place. Prior to fixing the clamps, ensure that the contact area of the work piece is free from rust, paint, grease etc. as this will result in a poor welding connection and poor results.

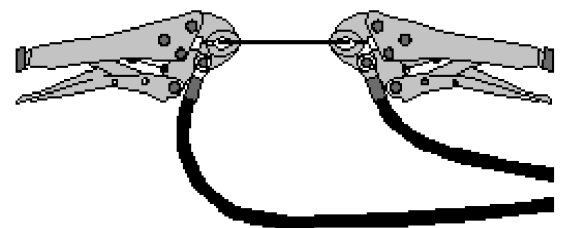

SETTING UP & WELDING

SETTING UP & WELDING

Connect the weld pistol link cable between the bowl feed unit and the weld controller. Connect the welding pistol cable to the bowl feed unit. Note that the cable end plugs have a peg to match with the key slot on the panel mounted weld sockets.

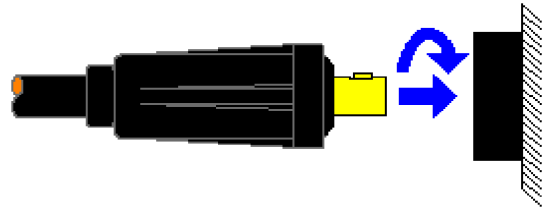

IMPORTANT! Secure the connectors with a clockwise turn until they lock. Failure to do this will result in damage to the connectors during welding

Connect the control link cable between the bowl feed unit and the weld controller. Connect the welding pistol control cable to the bowl feed unit. Note that the cable end plug and panel mounting socket are keyed to prevent incorrect fitting. Push the plug firmly home and twist the locking ring clockwise to secure the plug in position.

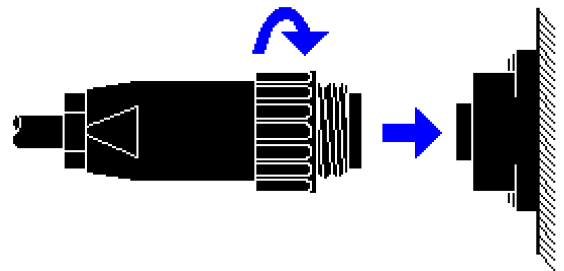

Connect the air pipes from the pistol or weld head to the pneumatic outlet of the bowl feed unit.

Note, the normal position of the pistol push rod is out when the air is turned on.

CD & DA Auto Handtool

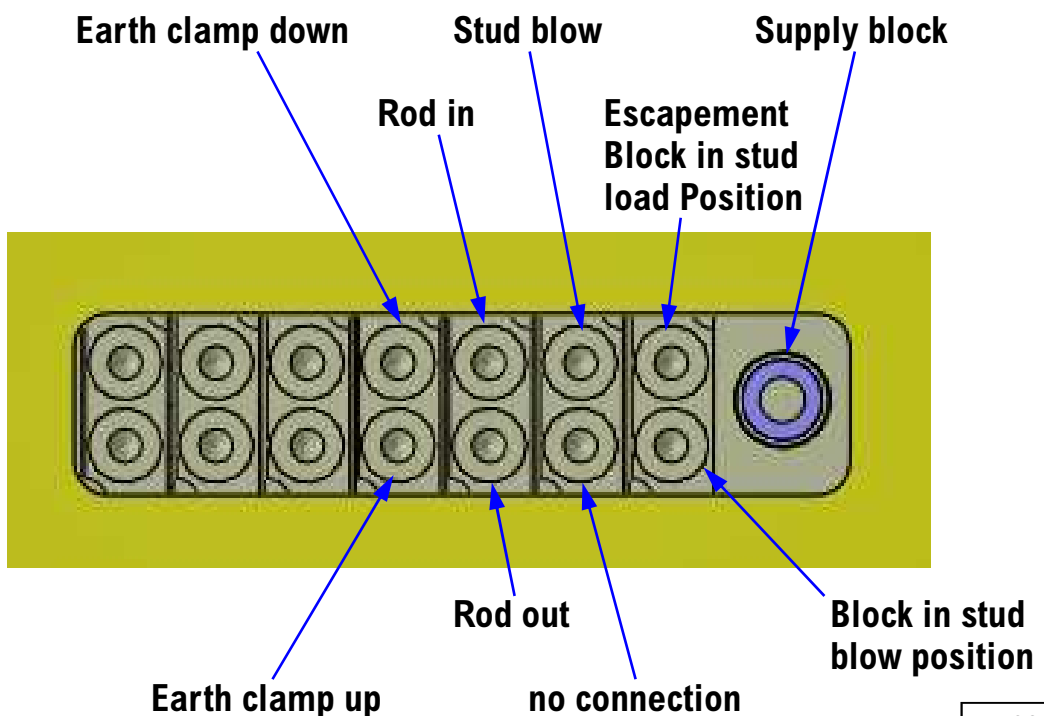

V—3C

SETTING UP & WELDING

SETTING UP & WELDING

CD & DA side feed auto weld head

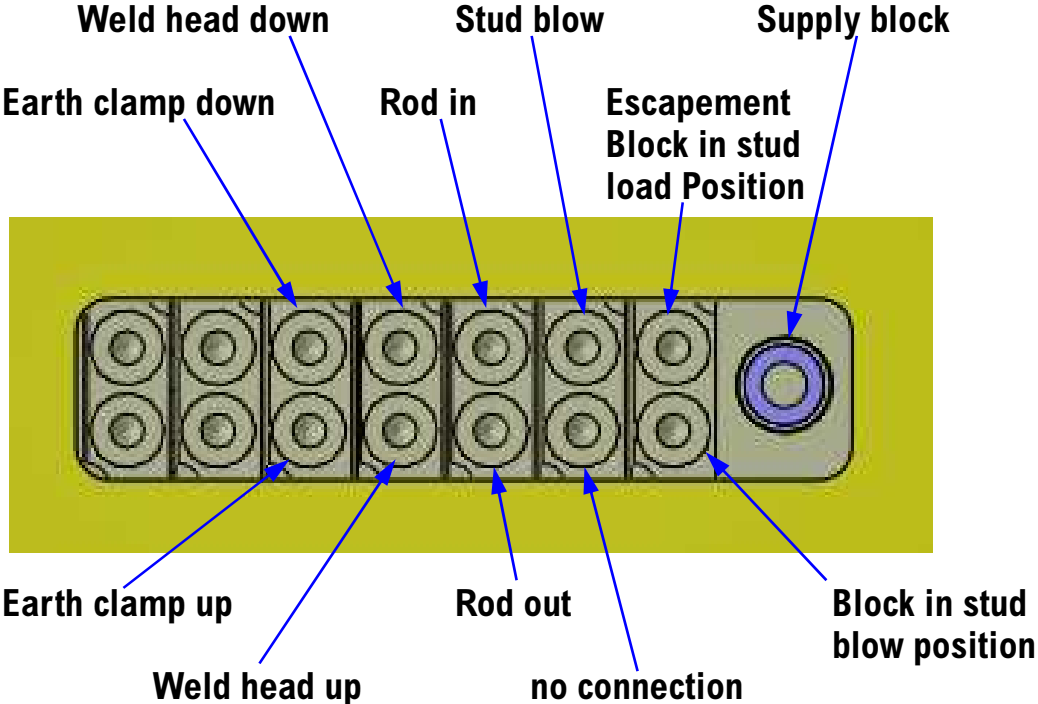

CD SIK2 approach weld head

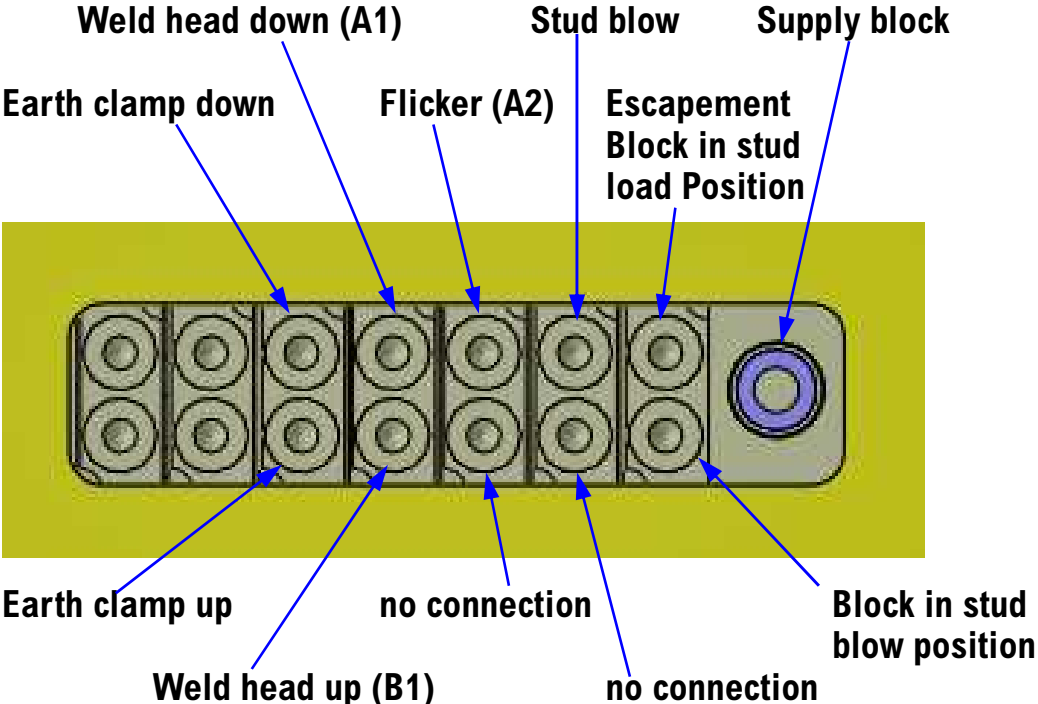

SETTING UP & WELDING

ELECTRICAL CONNECTION DIAGRAM AUTO PISTOL

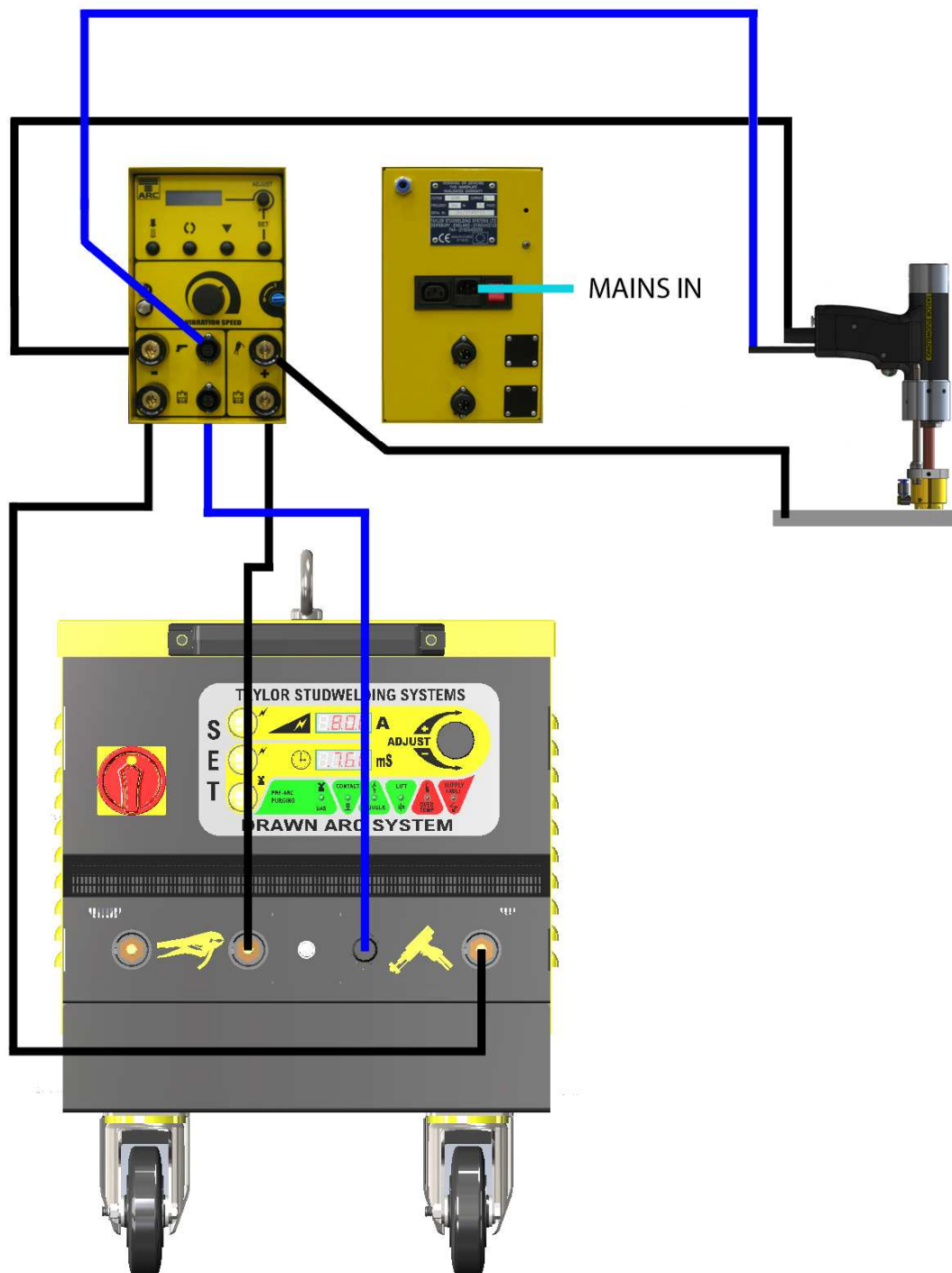

SETTING UP & WELDING

ELECTRICAL CONNECTION DIAGRAM SIK WELD HEAD

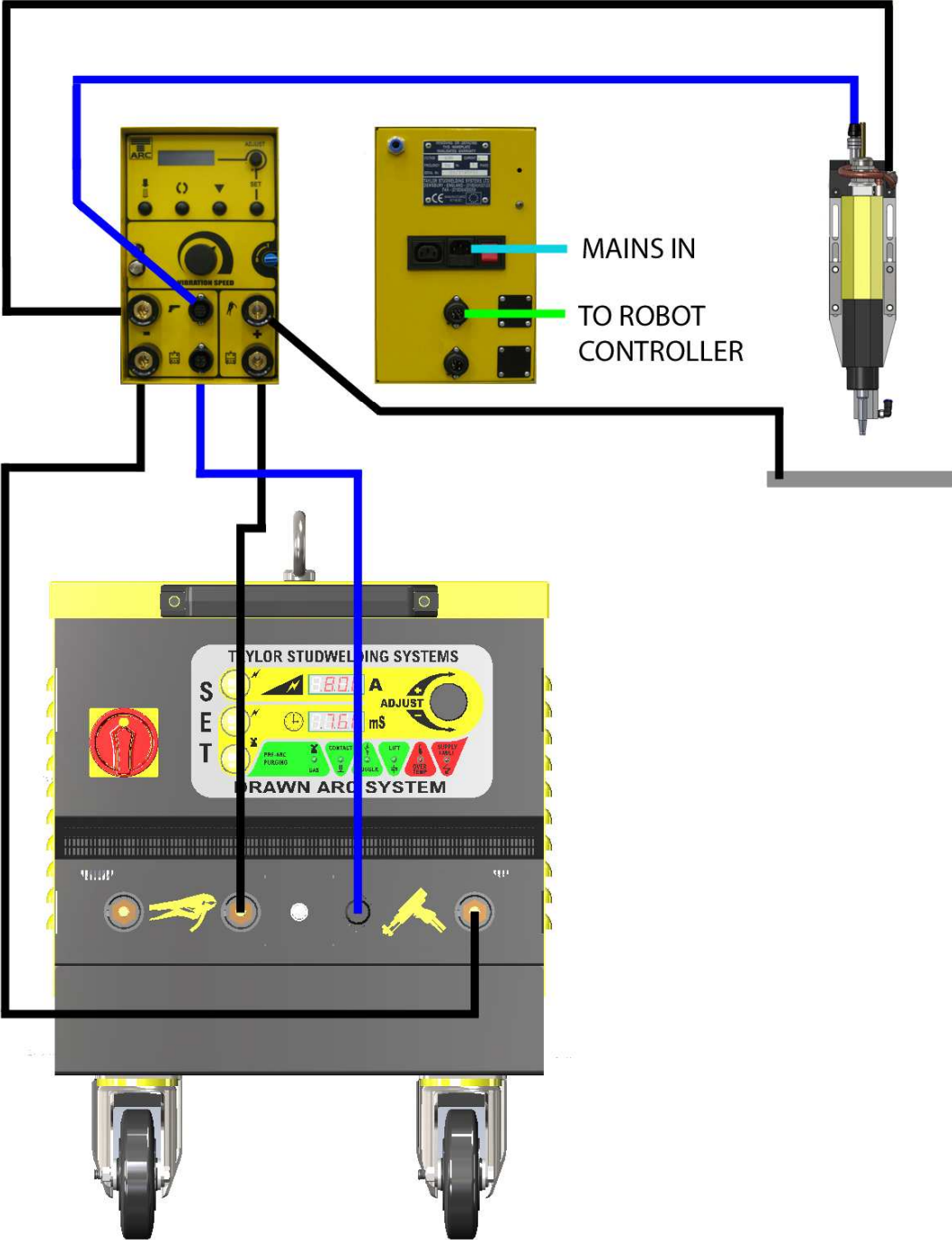

SETTING UP & WELDING

ELECTRICAL CONNECTION DIAGRAM CD AND DA WELD HEAD

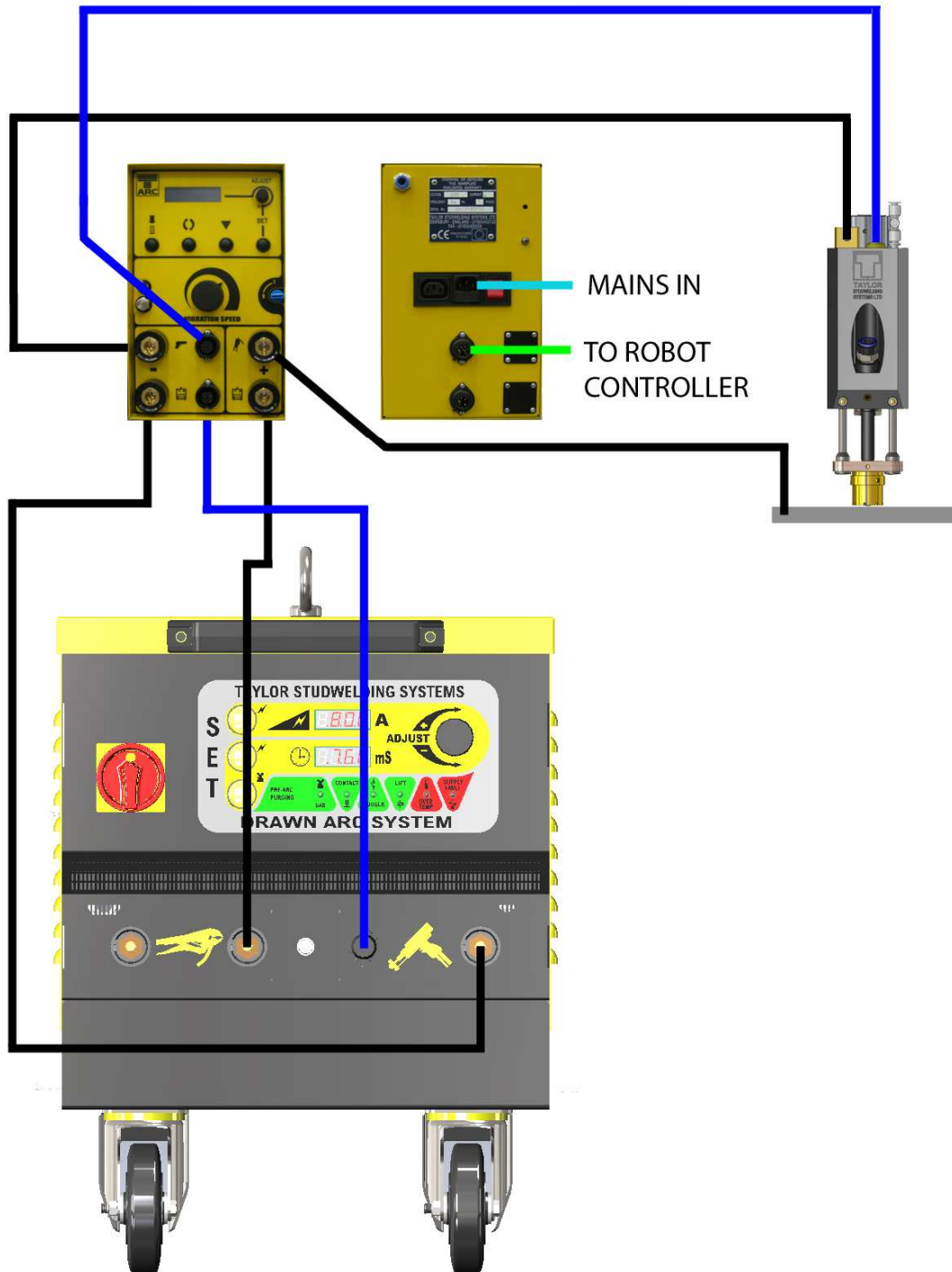

SETTING UP & WELDING

ELECTRICAL CONNECTION DIAGRAM STEPPER WELD HEAD

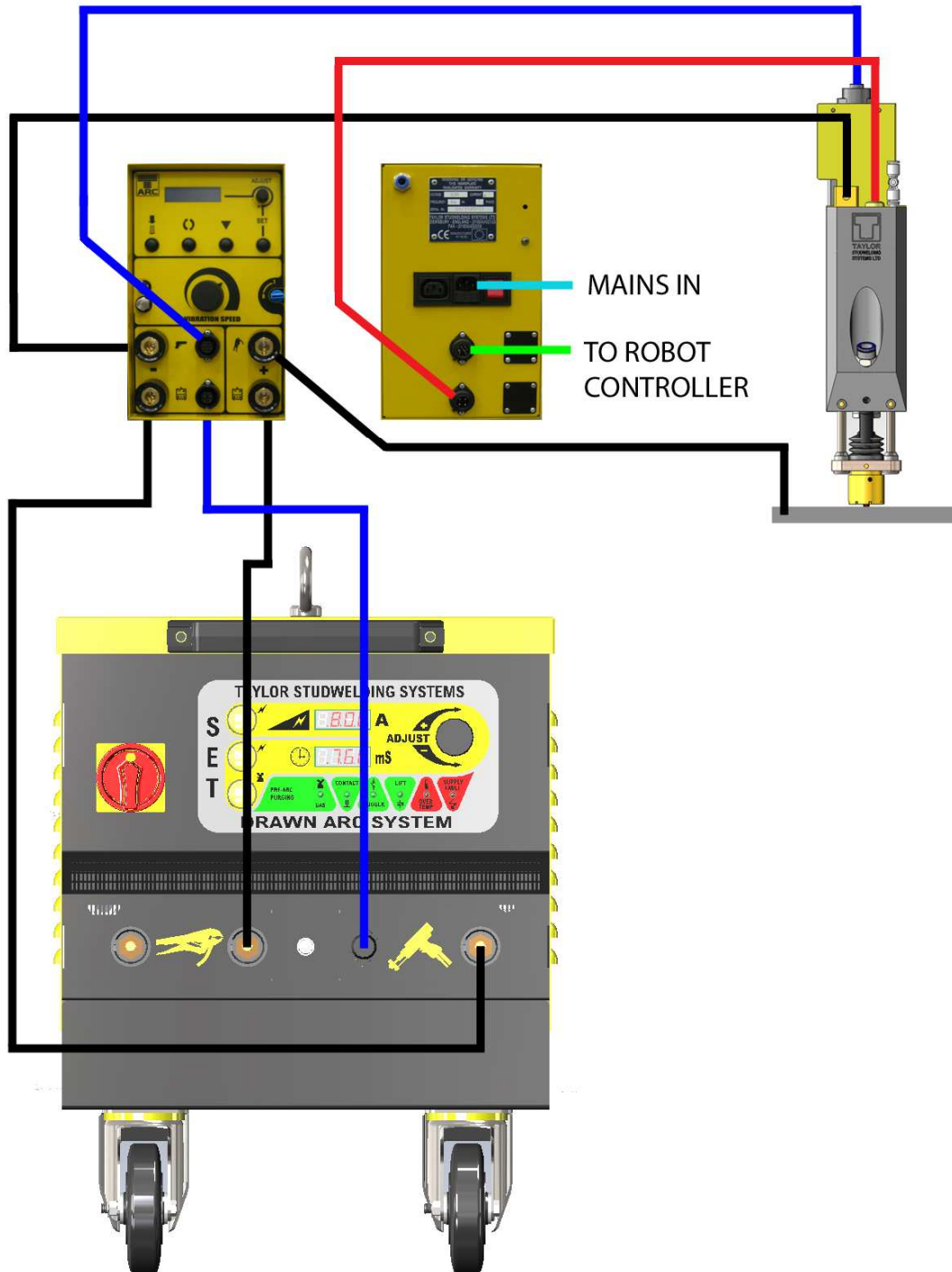

SETTING UP & WELDING

SETTING UP & WELDING

Connect the bowl feed unit to the factory air supply using suitable 8mm outer diameter pneumatic pipe.
Push the pipe into the one touch fitting until it is fully home.

air inlet

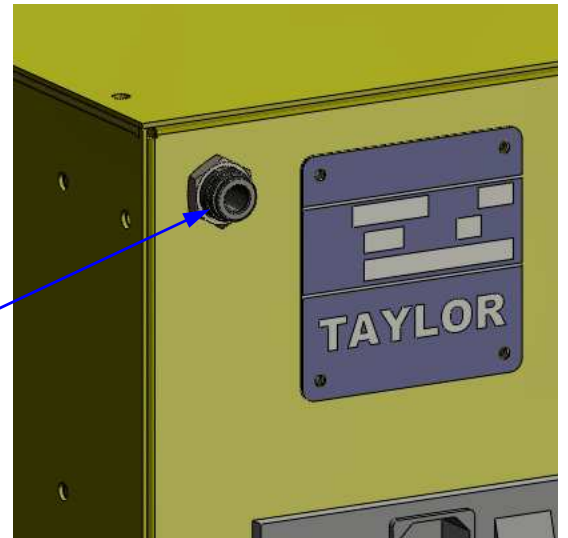

Turn on the air supply with the pneumatic shut-off valve.
Adjust the pressure gauge to give a minimum supply pressure of 5.5 bar.
If the pressure is allowed to fall below 5.5 bar there may be feeding and welding problems.

pressure adjuster

pressure gauge

pneumatic shut-off valve (shown on)



SETTING UP & WELDING

SETTING UP & WELDING

Select the required weld stud on the basis of diameter, length and material. See our separate catalogues: Capacitor Discharge Stock list and Drawn Arc Stock list, which are available from your local sales representative.



SETTING UP & WELDING

SETTING UP THE BOWL & ESCAPEMENT

Set up the escapement and bowl feeder as shown in the escapement manual.

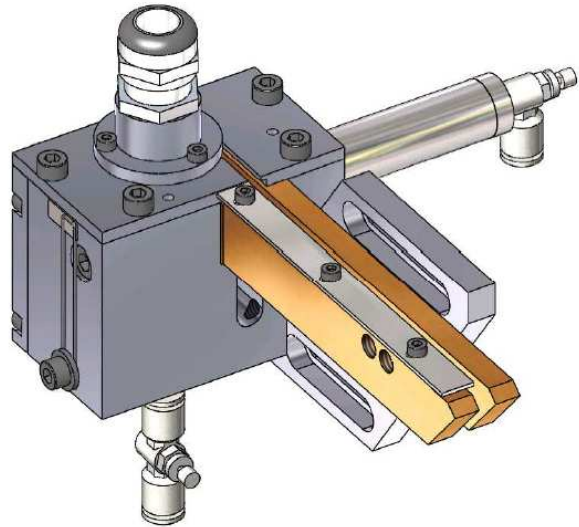

Ensure that the pneumatic shut-off valve (see page 14) and mains power switch (see page 12) are turned on.
Press the feed switch button to test the feeding system.

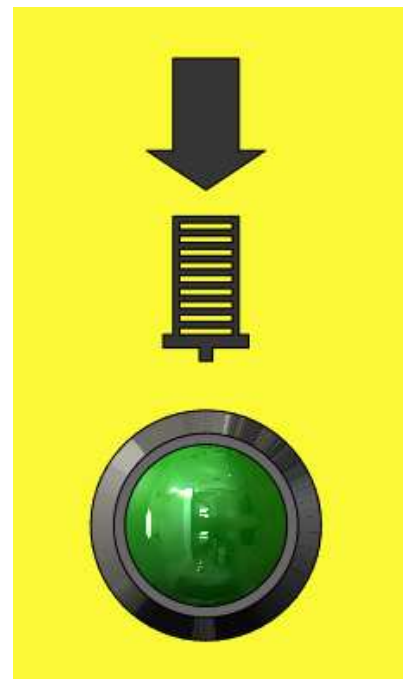

SETTING UP & WELDING

SETTING UP THE BOWL & ESCAPEMENT

If the stud jams in the pistol press the pushrod toggle button, this retracts the rod to allow a jam to be cleared. Press the button again to return the rod to its normal position.

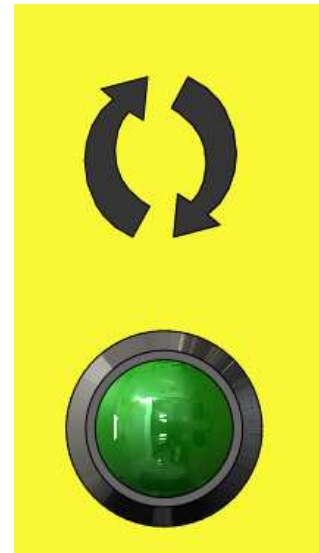

If the stud does not reach the pistol in time, even with maximum air flow, increase the blow time by turning the blow time adjuster clockwise.

Some systems have an extra time adjust function see the documentation for the system in use

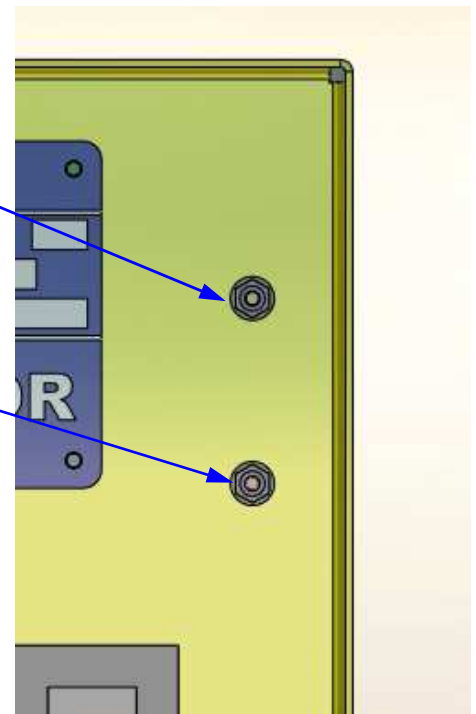

Adjust the vibration speed to match the feed rate of the bowl and the weld rate of the pistol. This may need to be adjusted as the quantity of studs in the bowl varies, i.e. as the quantity of studs falls, the vibration speed may need to be increased.



SETTING UP & WELDING

SETTING UP THE BOWL & ESCAPEMENT

Reset/Earth select button - this button has a different function depending on the type of system in use:

For systems used with an external controller it is a reset switch - if there is a fault with the controller, i.e. no studs in the escapement, the fault signal will turn on and the system will not weld. Press this button to reset the system once the fault has been cleared.

For stand alone systems this is an earth select switch, with the switch pressed in the earth clamp will turn on and off with each weld, with the button out the earth clamp is not used.



LCD, Adjust knob and Set button - These are used to adjust the weld parameters when using the stepper weld head, see the stepper weld head manual for details.

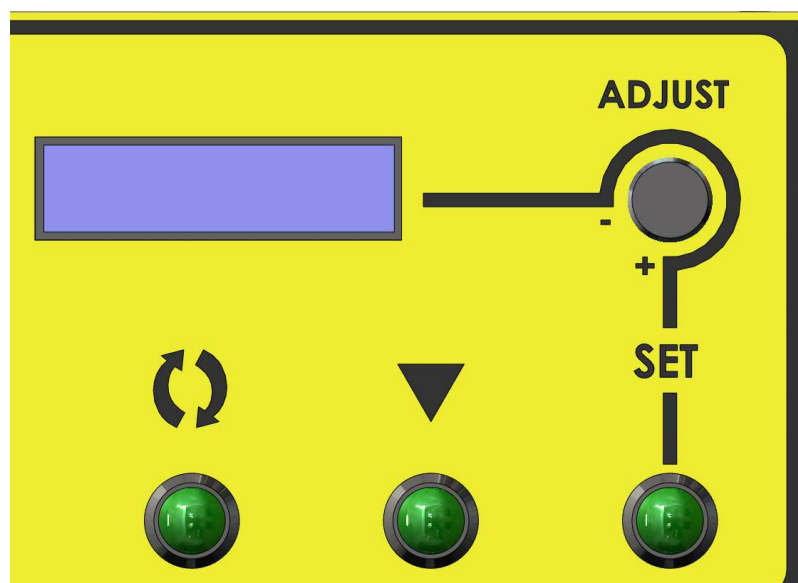

SETTING UP & WELDING

SETTING UP THE WELD CONTROLLER

Set up the capacitor discharge or drawn arc weld controller as shown in the manual appropriate for that piece of equipment.

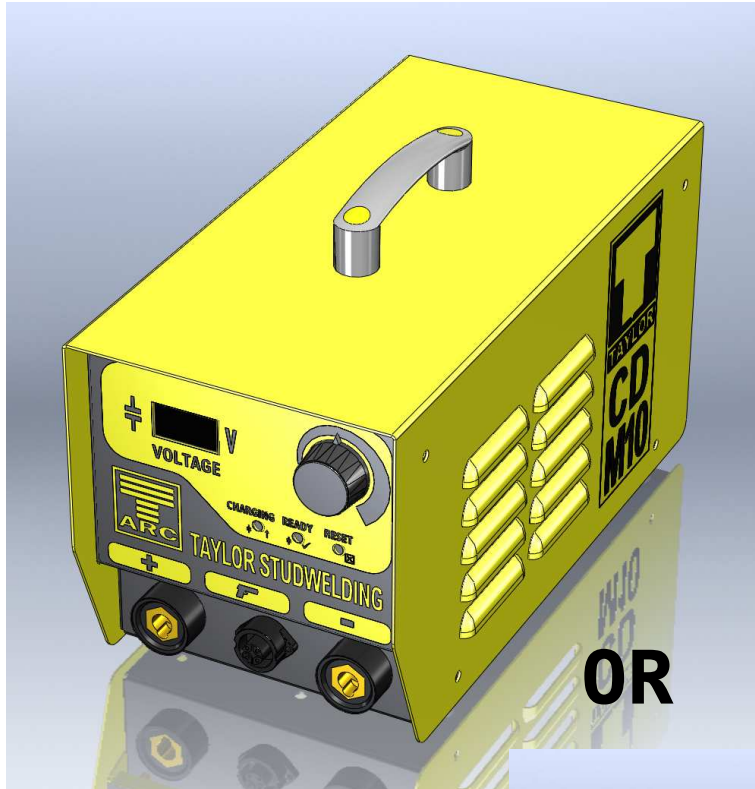

OR



V-3C

SETTING UP & WELDING

SETTING UP THE HANDTOOL OR WELD HEAD

Set up the capacitor discharge or drawn arc handtool or weld head as shown in the manual appropriate for that piece of equipment

CD or DA handtool

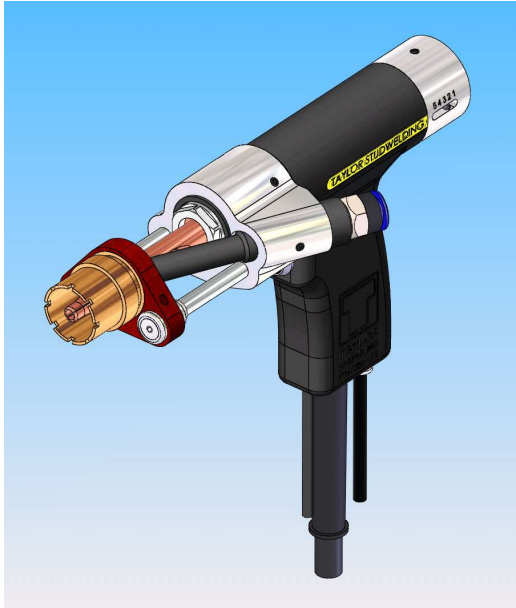

CD contact or DA weld head



CD SIK2 approach weld head

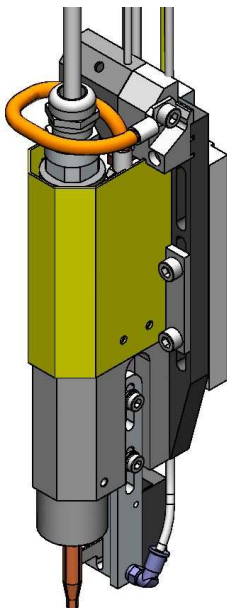

DA Stepper weld head

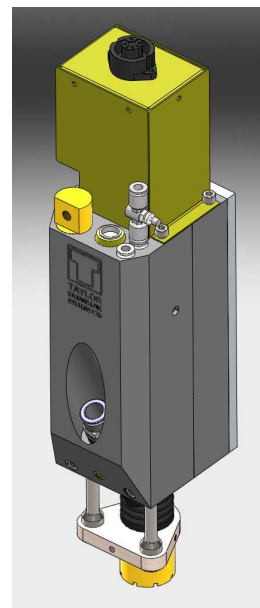

WELD QUALITY

VISUAL ASSESSMENT OF WELD QUALITY

A cold stud weld is noticeable by undercutting of the flange and lack of / minimal formation of spatter. A cold weld is usually caused by too little energy and / or too fast a plunge speed.

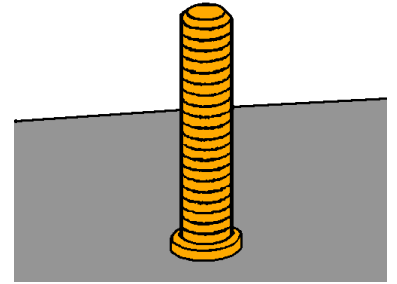

A hot stud weld is noticeable by excessive spatter formation and partial melting of the flange. A hot weld is usually by too much energy and / or too slow a plunge speed.

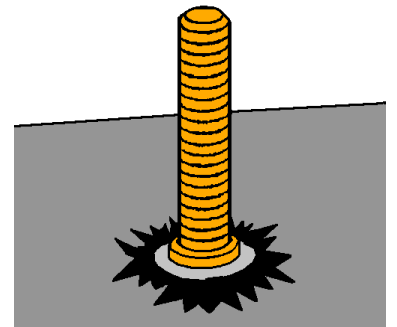

A one sided stud weld (arc blow) is usually caused by incorrect earthing of the work piece. This may be corrected by placing the welding earths opposite each other across the area where the weld is to occur.

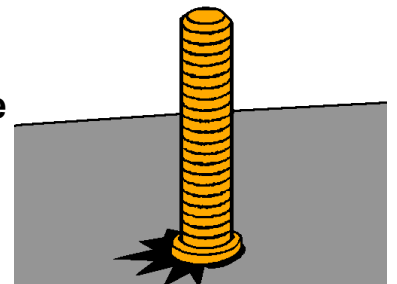

Finished studs may be subjected to a bending test to ascertain the strength of the weld. This may be achieved by placing a bending bar assembly, fitted with the correct nozzle, over the stud and bending the stud through 30° and then back to the vertical. This test follows the specification of DVS 0905 part 2.

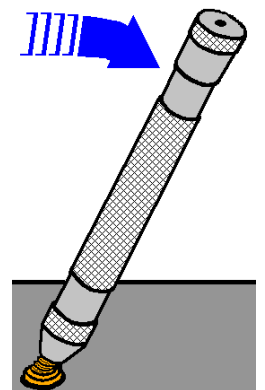

A simpler test may be achieved by bending the stud over 30° using a hide mallet.

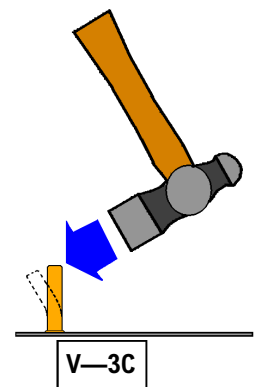

WELD QUALITY

Visual examination of weld quality can, even with limited experience, provide a useful quality assessment. In such a check the presence of a small even witness of weld material around the base of the stud flange after welding should be ensured. Poor welds are indicated by excess metal on one side of the welded flange and / or the presence of an undercut or non-fused area between the stud flange and the parent sheet or plate. Incorrect settings, adverse magnetic effects etc. such as those at edge welding positions or with unbalanced earths and studs welded to the work piece at an angle, the controller and pistol should be examined with a view to correcting such defects.

MECHANICAL TESTS :

① BENDING.

The most easily applied method of testing the quality of welded fasteners considered here, involves the use of a bending bar. This bending bar (available from your supplier, see the accessories section of this manual) fitted with the correct size of nozzle for the stud to be tested is used to bend over the stud in accordance with the DVS0905 (German Welding Society Spec') specification .

② TORSION.

A torsion test provides useful information for threaded fasteners. This involves tightening a nut on the stud against a spacer, suitably relieved to cater for the flange and weld spatter. For quantitative assessments a suitably calibrated torque wrench may be used, but at its simplest, a spanner will suffice.

In the above tests the performance of the welded joint should be considered in relation to the thickness of the material to which the stud is welded. On thicker materials, a full strength weld is denoted by deformation or failure of the stud shank. On lighter gauge material, severe "dimpling" or "dishing" at the reverse to the weld side normally indicates sufficient strength, whilst in most cases, the tearing of a slug of material from the parent sheet will occur.

TROUBLE SHOOTING

Fault / Error	Cause	Remedy
Sudden decline in weld quality	Worn welding contacts	Check the contacts of the collet & earth clamps. Replace worn out parts
	Welding energy too high or too low	Too much spatter around the weld area: energy too high - decrease the weld voltage
		No spatter around the weld area: energy too low - increase the weld voltage
	Burnt welding cable plug and sockets. Welding cable damaged	Check the weld cables and replace as necessary
	Plunge speed of the stud too fast or too slow	Check the spring or lift settings in the pistol
	Dimensions of the stud tip outside of tolerance	Check the dimensions of the stud tip. The size and tolerance must be to EN ISO 13918
	Wrong stud material	Check the material of the stud, it must be suitable for welding
	Wrong workpiece material	Check the material of the sheet, it must be suitable for welding
Workpiece surface contaminated	Check the surface of the sheet, it must be clean & free from oil or grease	

TROUBLE SHOOTING

Fault / Error	Cause	Remedy
Studs show material ejected to one side only	Arc blow effect. Earthing contacts not applied evenly	Apply earthing contacts symmetrically to the weld position
Burn marks on stud	Collet contact worn	Replace the collet
No stud in the collet	Stud blockage in the stud feeder	Check the vibrator bowl and stud feeder
	Feed tube	Check that the feed tube is fully inserted into the pistol. If the feed hose is kinked, replace it
	Stud has not reached the collet	Check all the points through which the stud is guided, from the stud feeder down to the collet. Check the air pressure and air flow
	Several studs in the feed tube	Stud arriving at the pistol after the pushrod has returned. Increase the stud blow air flow, or increase the stud feed time
	Worn out collet	Replace the collet

SEQUENCER COMPONENT EXPLOSION

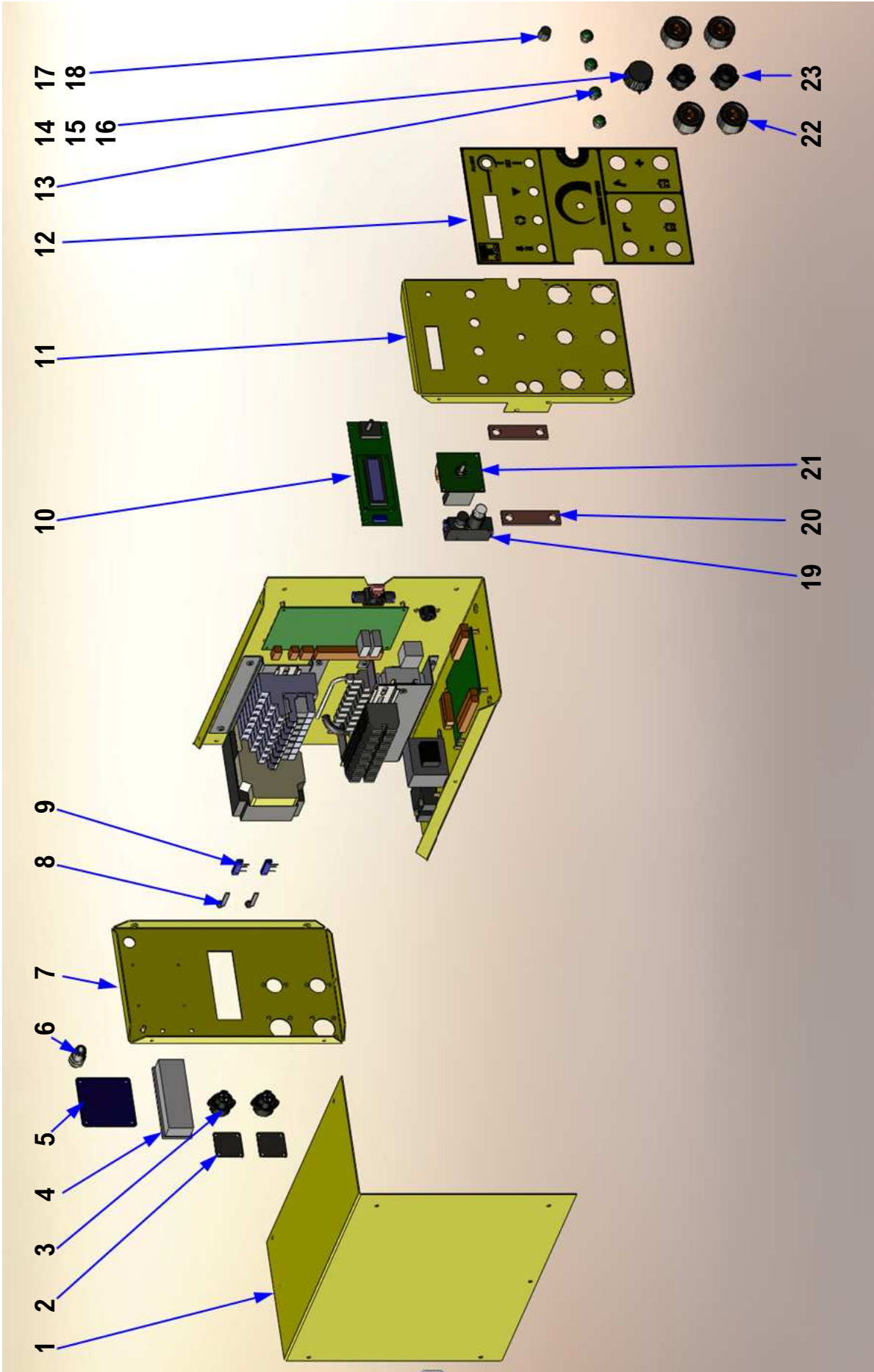

SEQUENCER COMPONENT EXPLOSION

ITEM No	QTY	DESCRIPTION	PART No
1	1	MAIN COVER	72-103-258
2	2*	COVER PLATE	72-103-114
or	1*	14 WAY CHASSIS PLUG	75-102-008
or	1*	17 WAY CHASSIS PLUG	75-102-010
3	2*	COVER PLATE	72-103-115
or	1*	7 PIN PANEL SOCKET	81-101-088
or	1*	4 PIN PANEL SOCKET	70-102-054
4	1	IEC MAINS INLET/OUTLET	72-103-120
5	1	SERIAL PLATE	70-102-225
6	1	DIA 8 BULKHEAD FITTING	PFS-P08-BUL
7	1	BACK PANEL	72-103-252
8	2*	TRIMMER PANEL ADAPTOR	75-102-081
9	2*	100K TRIMMER	75-102-082
10	1 ¹	STEPPER DISPLAY CARD	72-103-266
or	1*	LCD BLANK COVER	72-103-255
11	1	FRONT PANEL	72-103-251
12	1	FACIA LABEL	72-103-259
13	4 ²	PUSH BUTTON	71-104-019
14	1	CONTROL KNOB	81-104-030
15	1	POINTER	81-104-031
16	1	KNOB CAP	81-104-032
17	1	15mm BLACK KNOB	81-104-033
18	1	15mm BLACK CAP	81-104-035
19	1	PRESSURE REGULATOR & GAUGE	71-200-217
20	2	BUSBAR	72-103-257
21	1	VIBRATION CONTROL MODULE	72-103-119
22	4	PANEL MOUNTED WELD SOCKET	81-106-031

SEQUENCER COMPONENT EXPLOSION

ITEM No	QTY	DESCRIPTION	PART No
23	2*	4 PIN PANEL SOCKET	70-102-025
or	1*	7 PIN PANEL PLUG	81-101-091

*** QUANTITIES DEPEND ON SYSTEM SPECIFICATION**

¹ ONLY FITTED TO VERSIONS WITH STEPPER WELD HEAD

² QUANTITIES DEPEND ON SYSTEM SPECIFICATION, SOME SYSTEMS HAVE 72-103-284 - LATCHING PUSH BUTTON SWITCH

SEQUENCER COMPONENT EXPLOSION

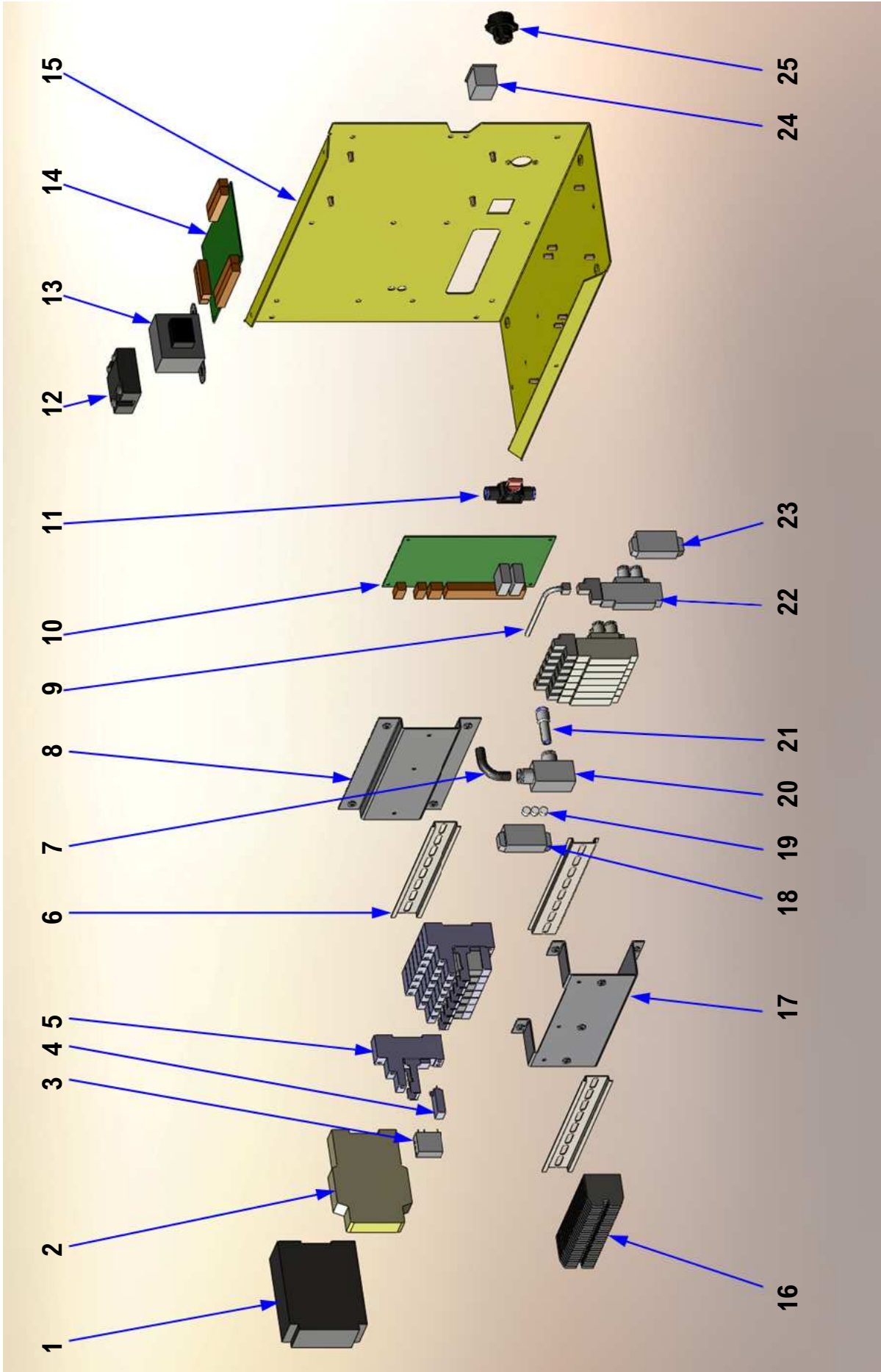

SEQUENCER COMPONENT EXPLOSION

ITEM No	QTY	DESCRIPTION	PART No
1	1 ^a	48V POWER SUPPLY	75-101-803
2	1*	EMERGENCY STOP UNIT	75-101-775
3	4*	RELAY	75-101-714
4	4*	PROTECTION DIODE	75-101-716
5	4*	RELAY BASE	75-101-715
6	3	DIN RAIL (205mm)	81-108-109
7	1m	8 OD, 5 ID PNEUMATIC TUBE	71-200-188
8	1	RELAY BRACKET	72-103-254
9	3*	VALVE CABLE & CONNCETOR	75-101-758
10	1 ^a	STEPPER DRIVE CARD	72-103-265
11	1	PNEUMATIC SHUT-OFF VALVE	PVM-F32-P10
12	1	BOWL CONTROL RELAY	72-103-161
13	1	24V TRANSFORMER	72-103-267
14	1	PROGRAMMABLE CONTROLLER PCB	72-103-132
15	1	CHASSIS	72-103-250
16	20*	DIN RAIL TERMINAL	75-101-728
17	1	PNEUMATIC BRACKET	72-103-253
18	1	END PLATE (U SIDE)	PVA-S0B-BPM
19	3	VALVE BUSHING	75-101-761
20	1	SUPPLY BLOCK	PVA-S51-P10-BPM
21	1	DIA 10 TO DIA 8 PLUG-IN REDUCER	PFS-P08-T10
22	3*	SOLENOID VALVE	PVS-S52-P06-BPM
23	1	END PLATE (D SIDE)	PVA-S0A-BPM
24	1	IEC MAINS OUTLET	72-103-121
25	1	4 WAY CONTROL SOCKET	70-102-025
26	1	WIRING LOOM (NOT SHOWN)	72-103-149

* QUANTITIES DEPEND ON SYSTEM SPECIFICATION

^a ONLY FITTED TO VERSIONS WITH STEPPER WELD HEAD

BOWL FEEDER EXPLOSION

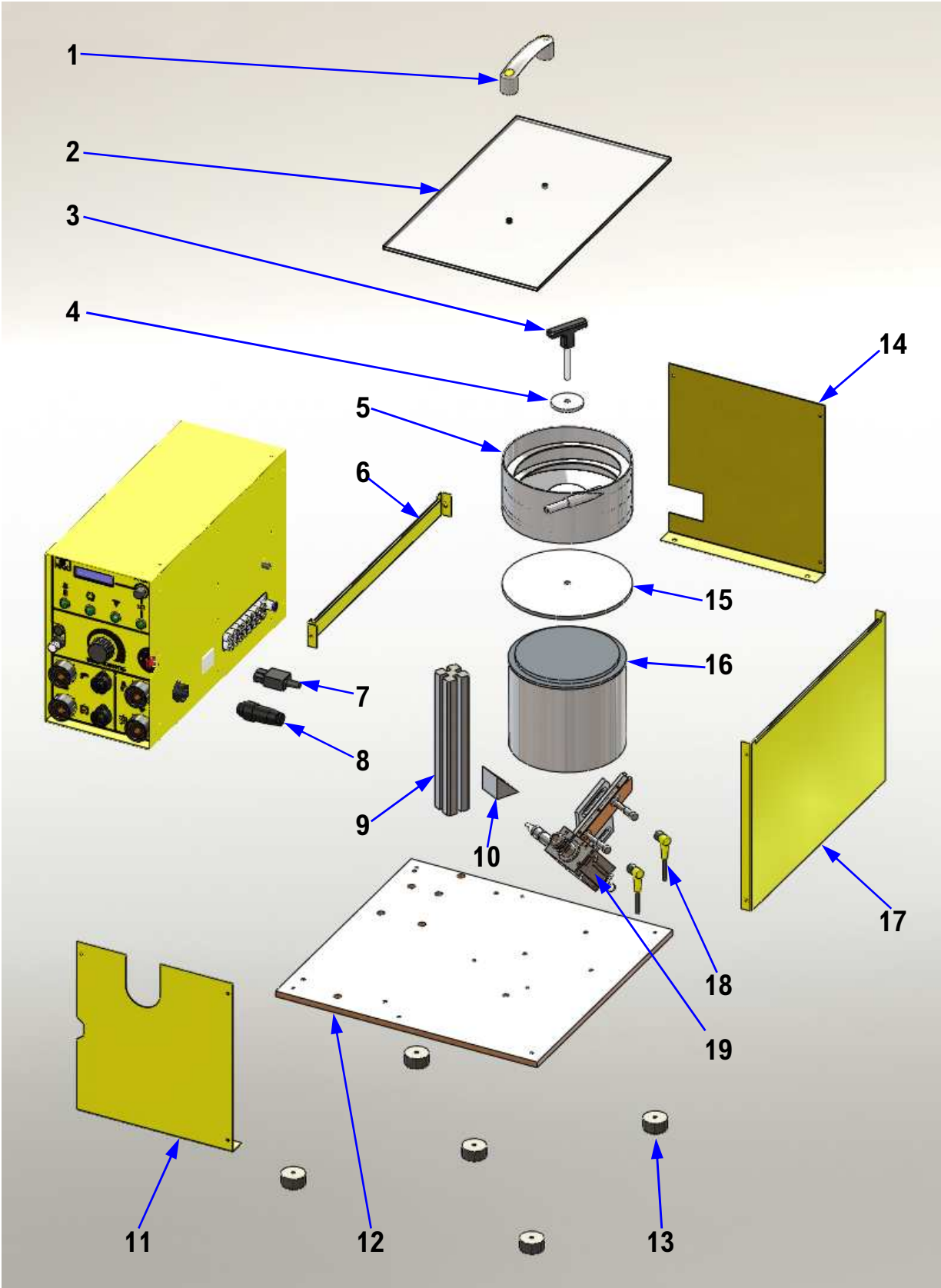

BOWL FEEDER EXPLOSION

ITEM No	QTY	DESCRIPTION	PART No
1	1	HANDLE	70-105-014
2	1	PERSPEX COVER	72-103-260
3	1	T — HANDLE	75-101-568
4	1	ANTI— ROTATION WASHER	71-103-151
5	1	BOWL TOP M3 TO M8	*
6	1	BOWL COVER SUPPORT	72-103-264
7	1	IEC PLUG	72-103-184
8	1	4 PIN CABLE PLUG	71-101-030
9	1	ESCAPEMENT SUPPORT COLUMN	72-103-128
10	1	SUPPORT BRACKET	72-103-129
11	1	BOWL COVER FRONT	72-103-261
12	1	BASEPLATE	72-103-256
13	5	FOOT	70-106-019
14	1	BOWL COVER BACK PLATE	72-103-263
15	1	SPACER PLATE	71-103-040
16	1	BOWL DRIVER (50Hz)	75-101-753
17	1	BOWL COVER SIDE	72-103-262
18	2	STUD SENSOR CABLE	72-103-268
19	1	ESCAPEMENT M3 TO M8	*

Note:

Item 16 is for use with a 50Hz supply only, a special driver can be supplied for use with a 60Hz supply.

* See Escapement & bowl feeder manual

PNEUMATIC DIAGRAM

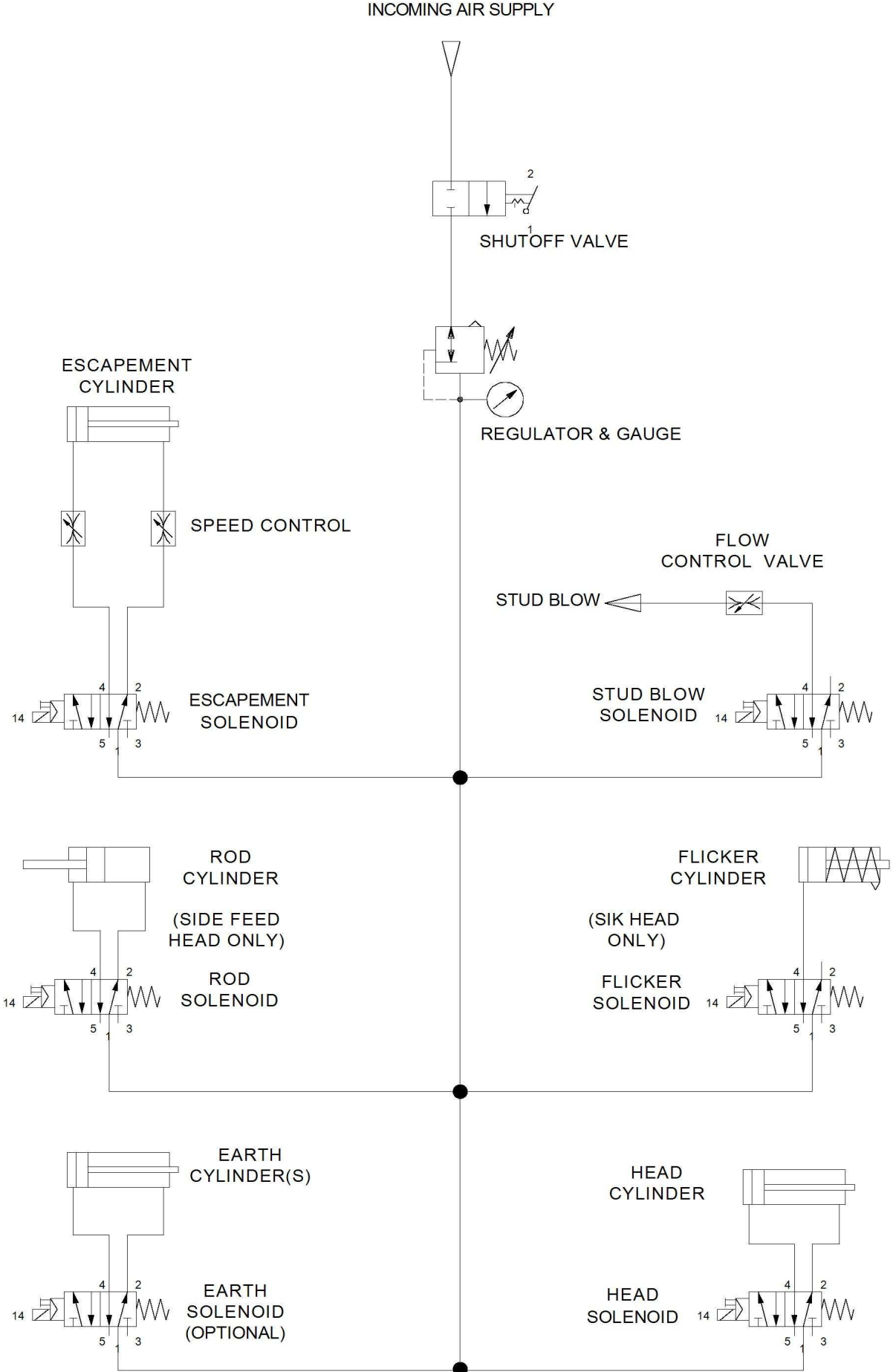

ELECTRICAL DIAGRAM CD PISTOL

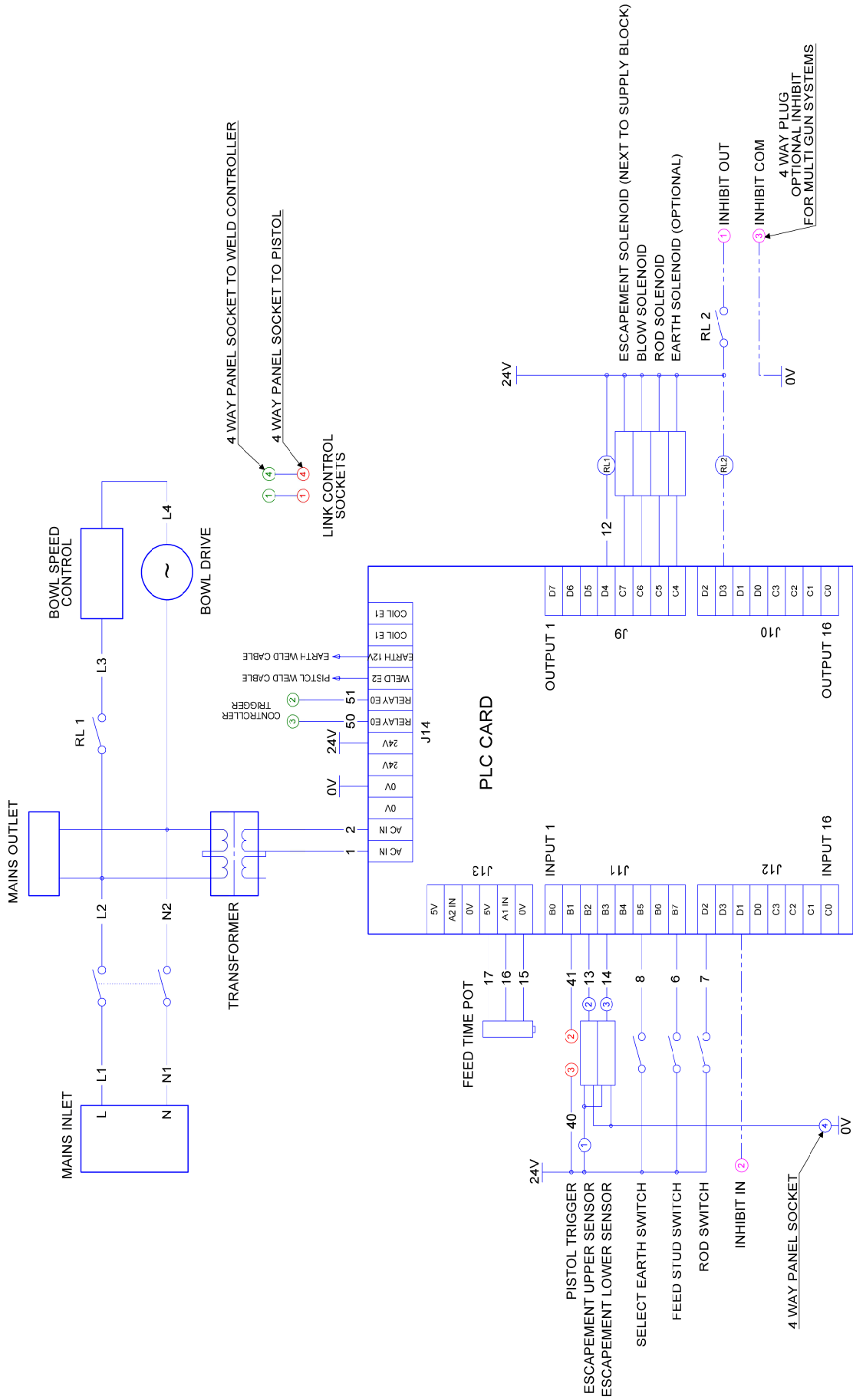

ELECTRICAL DIAGRAM CD WELD HEAD

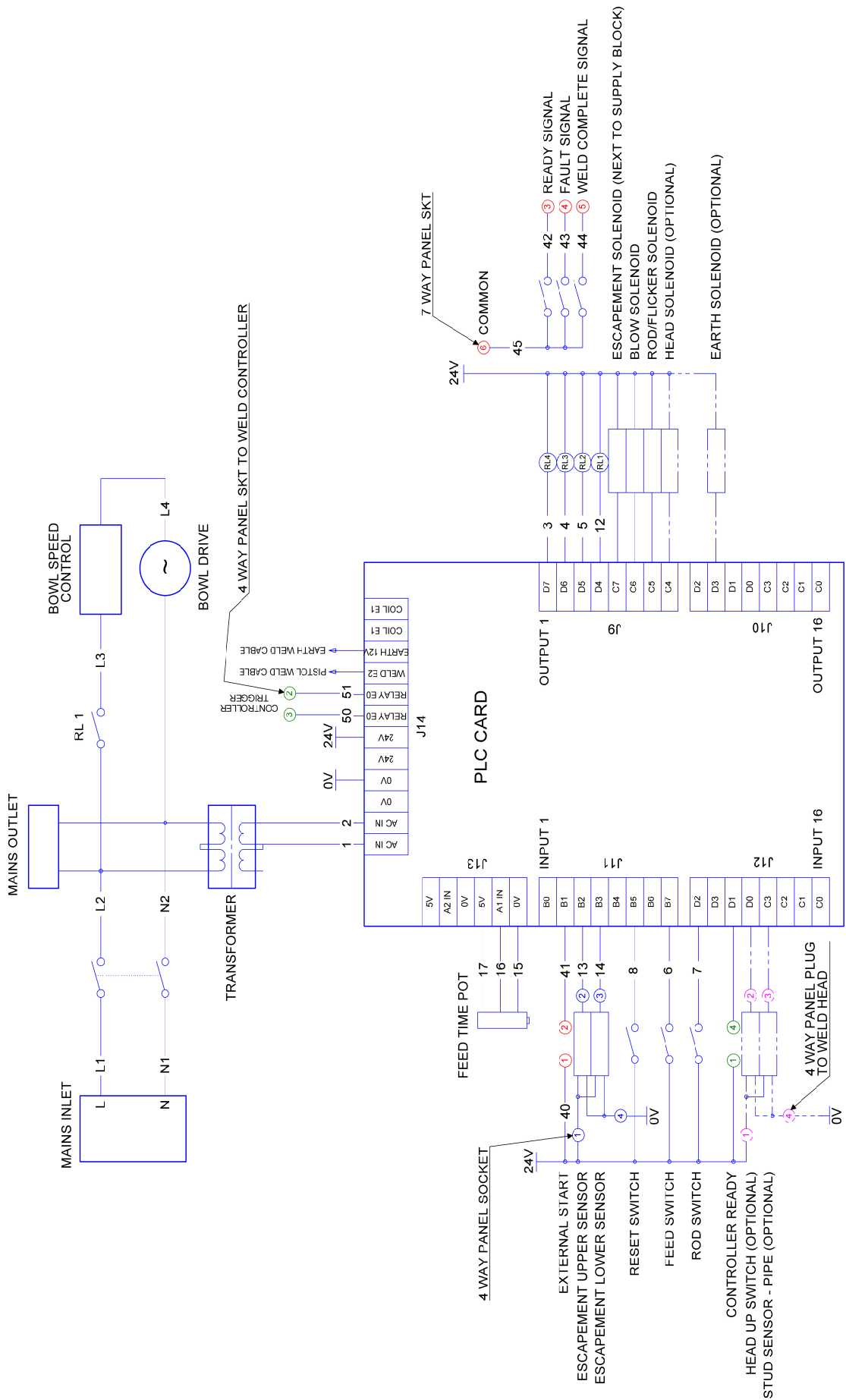

ELECTRICAL DIAGRAM DA PISTOL

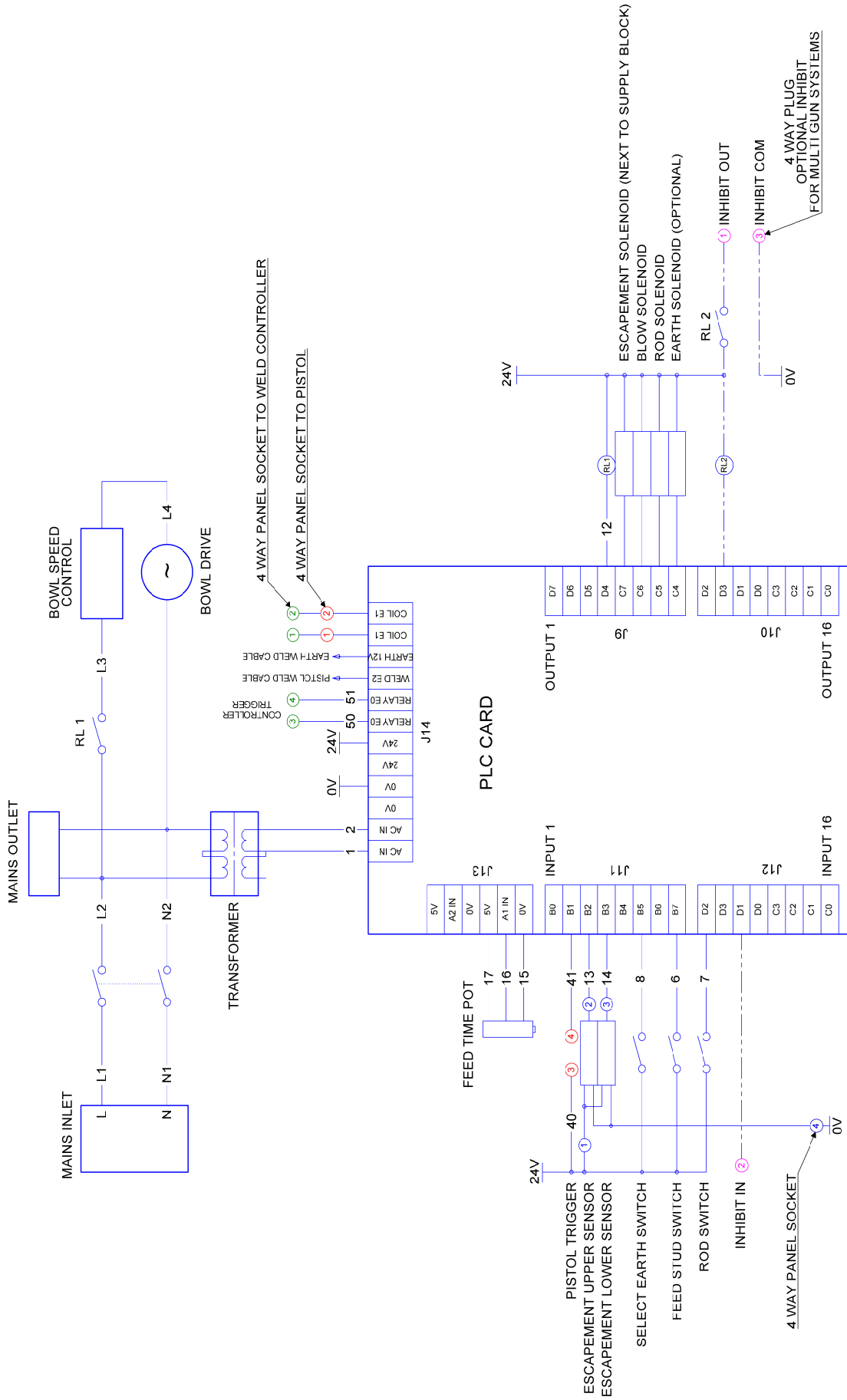

ELECTRICAL DIAGRAM DA WELD HEAD

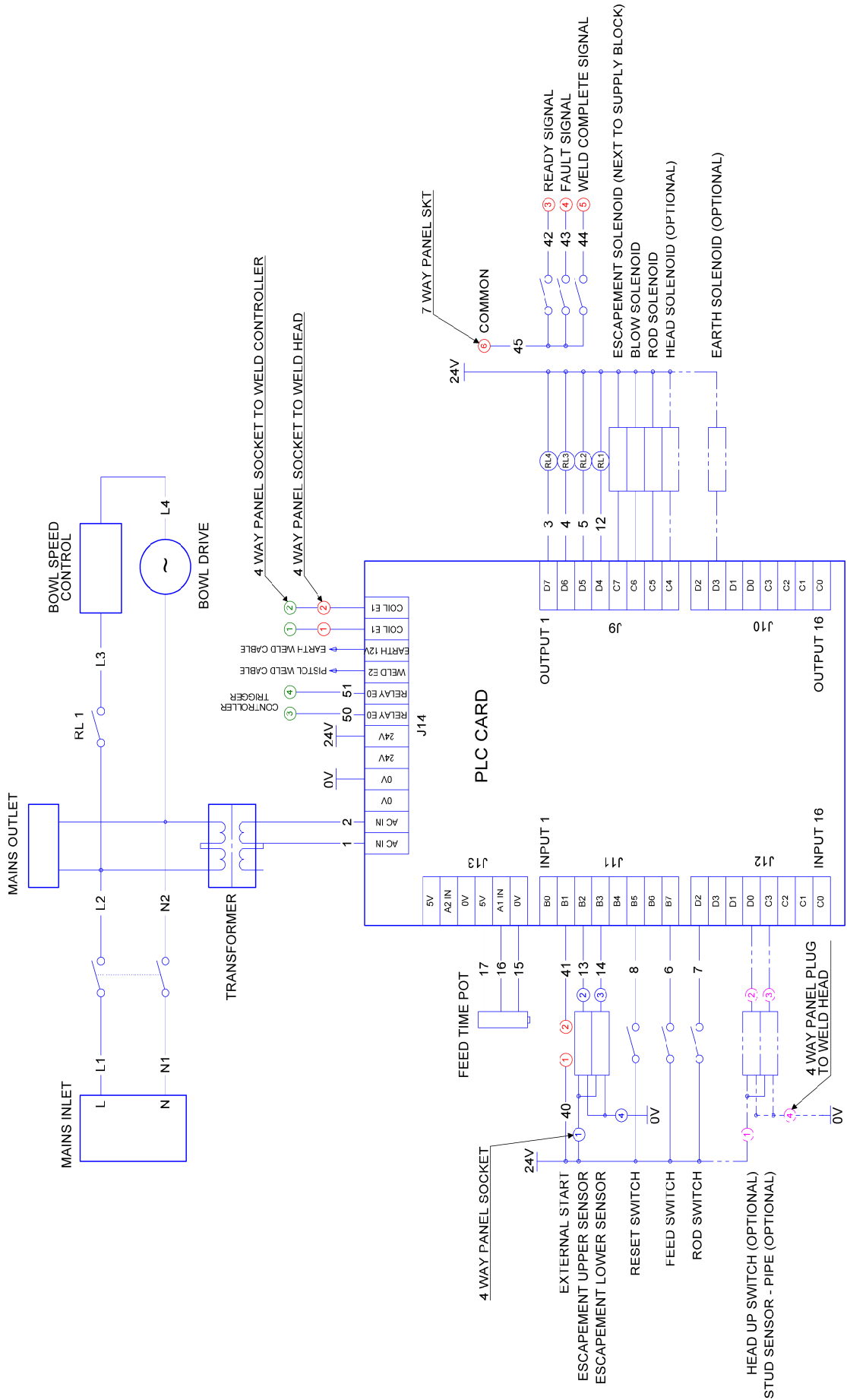

ELECTRICAL DIAGRAM STEPPER HEAD

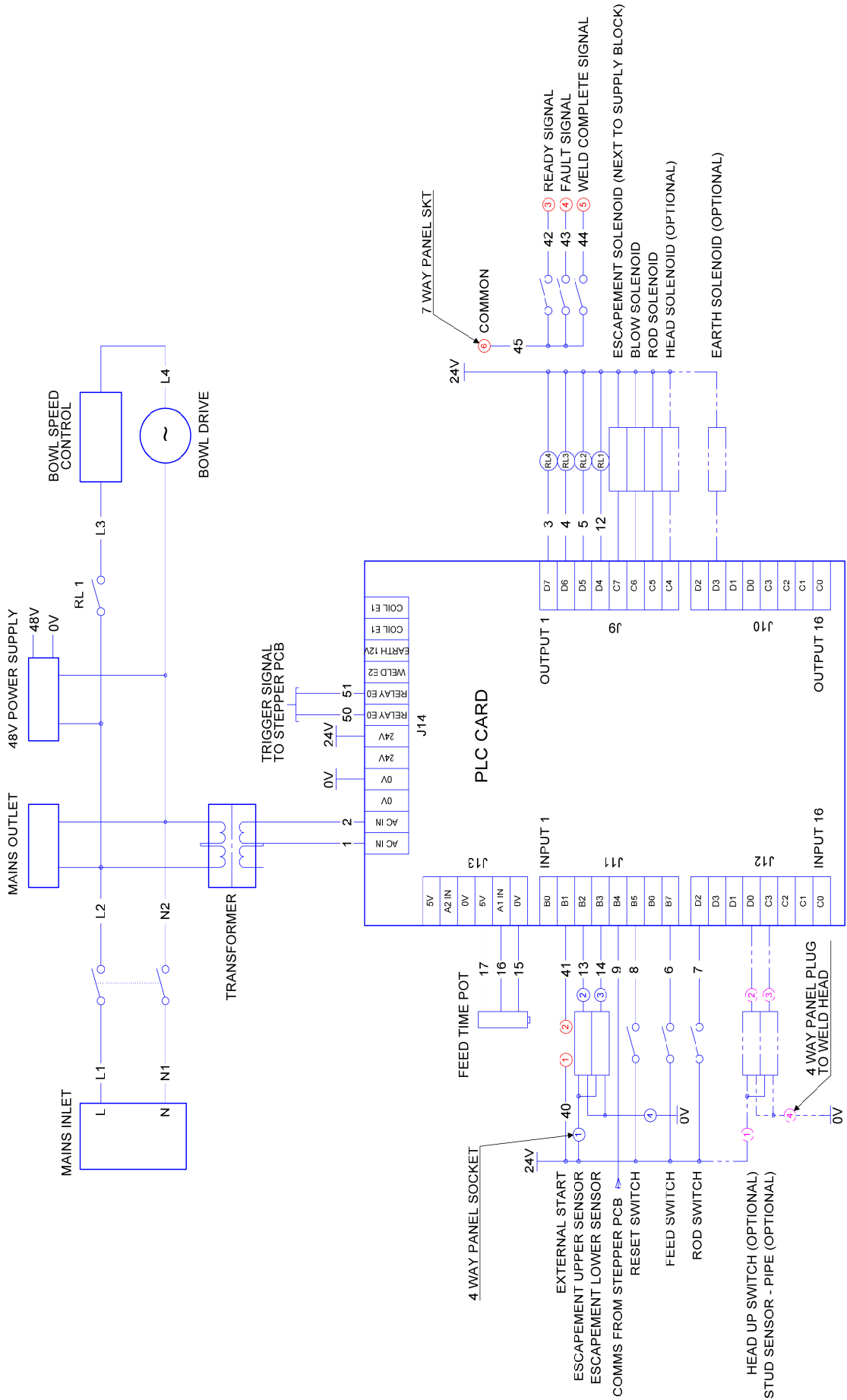

ELECTRICAL DIAGRAM STEPPER HEAD

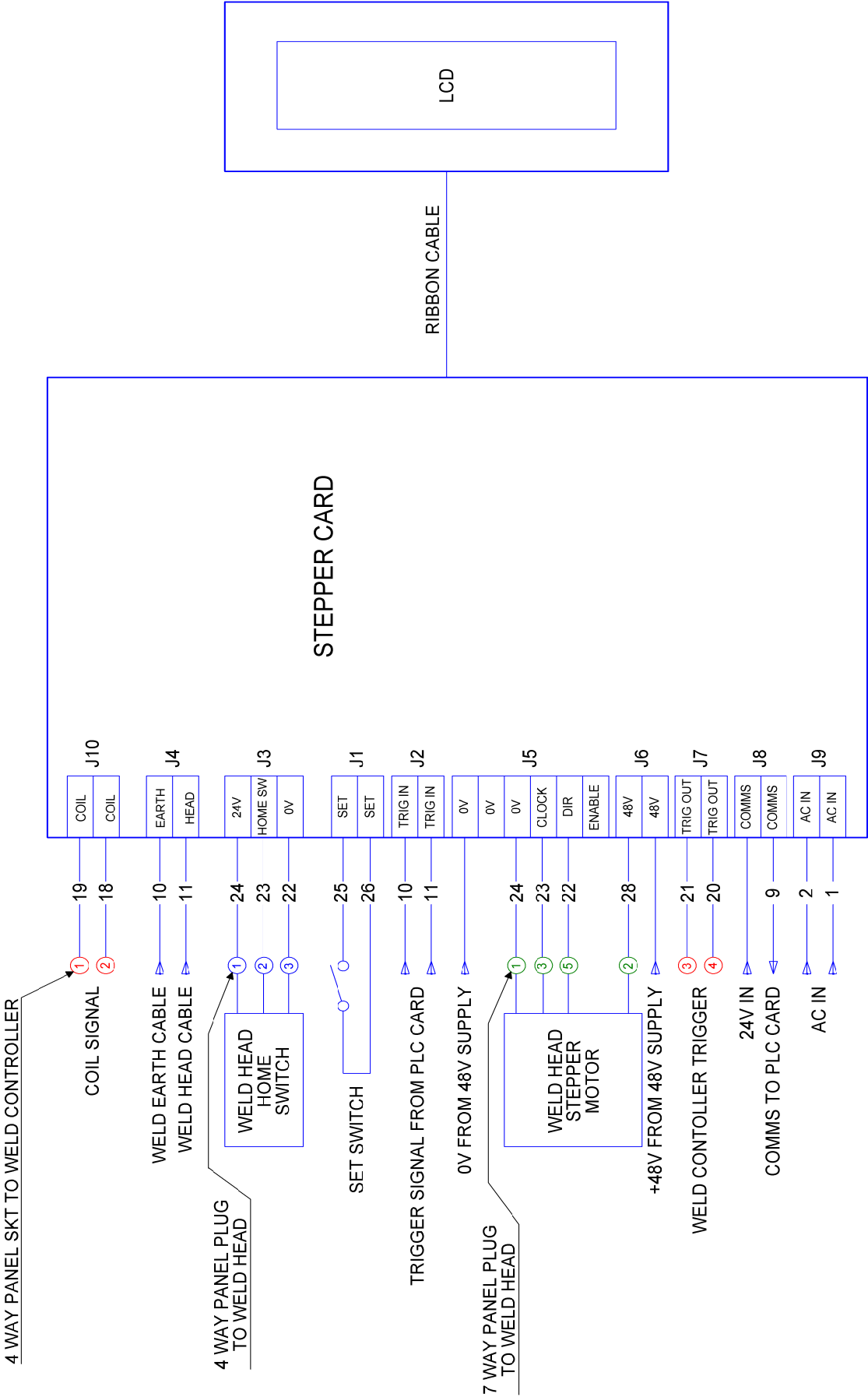

CONTROL SIGNALS

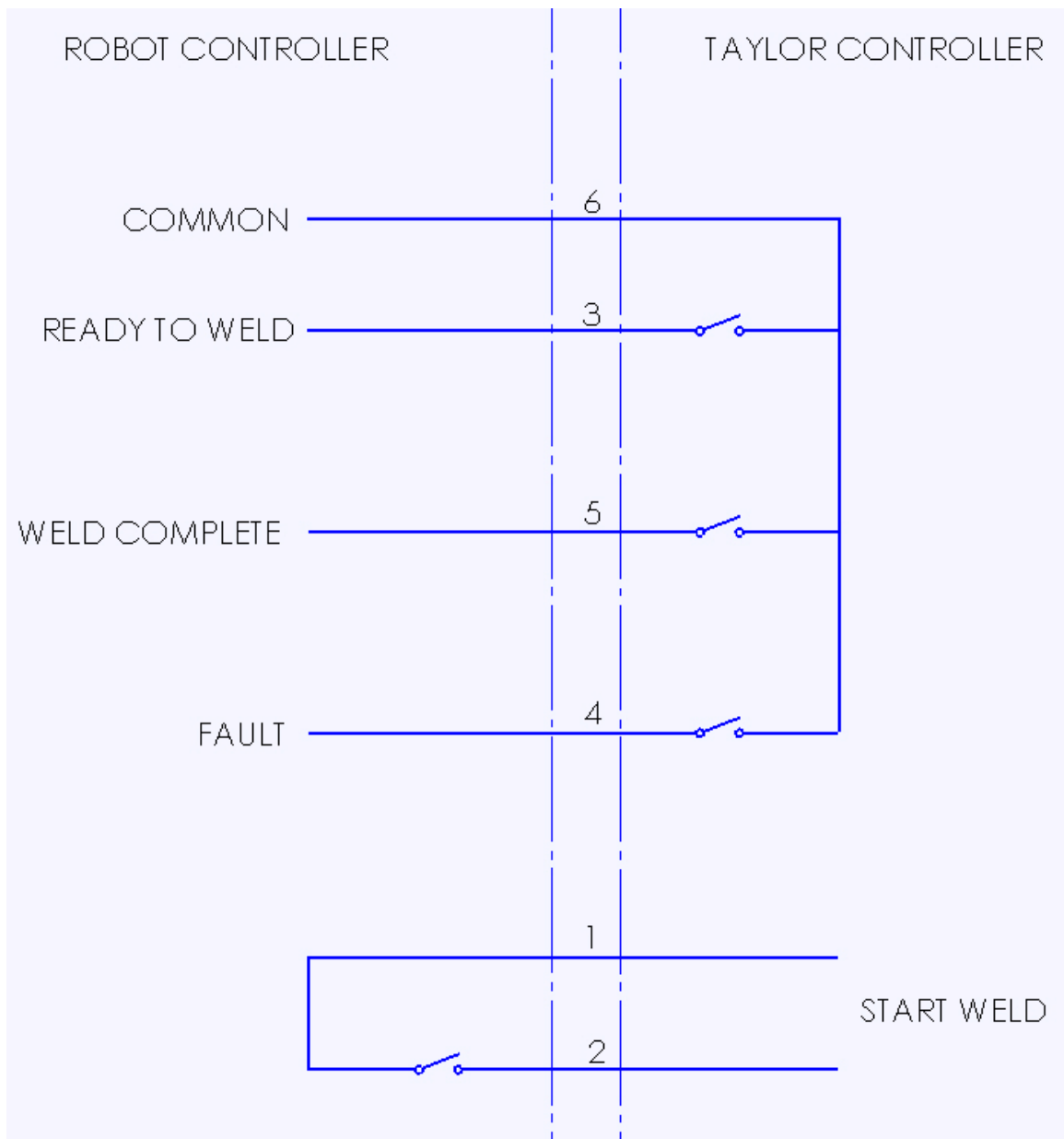

When used with external PLC or robot controllers 3 control signals are supplied by the Taylor control system, these are voltage free relay contacts with 1 common. The common can be wired to + or - as required by the robot control system.

The 'start weld' signal to the Taylor control system is a 2 wire trigger, these should be connected to a normally open relay in the robot control system. Closing the relay contacts will trigger the Taylor system.

WELD SEQUENCE

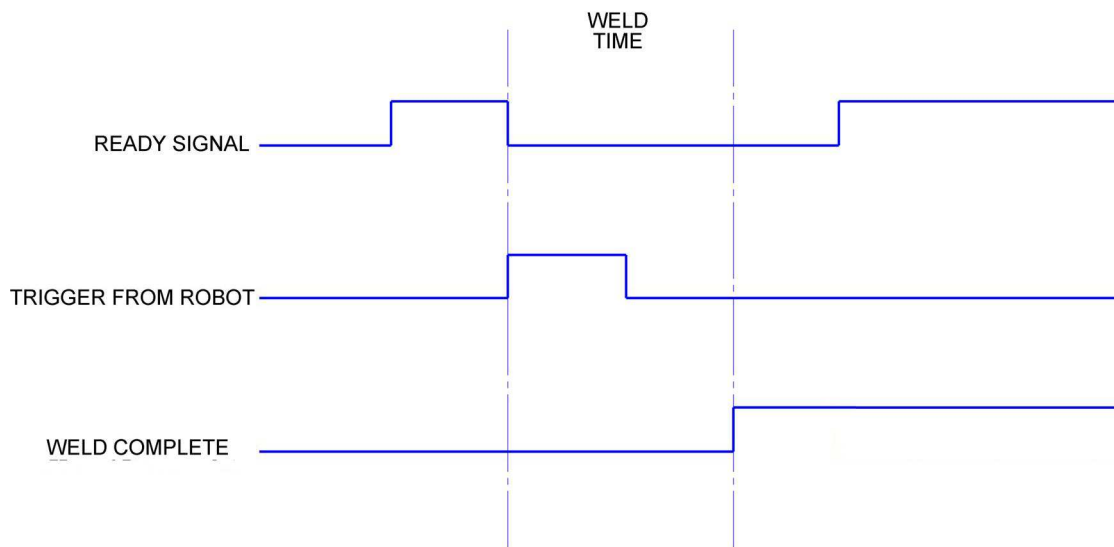

The signal sequence is shown above, the sequence of operation is shown below:

- 1) Move the weld head to the correct position to weld the stud, but leave it at least 5mm clear of the work-piece
- 2) Wait for the ready signal to turn on, then move the weld head down until it contacts the work-piece
- 3) Send the trigger signal to the Taylor system (approximately 100ms)
- 4) Wait for the weld complete signal, then lift head off the welded stud
- 5) Repeat steps 1 to 4 until all studs are welded

If the fault signal turns on the system will not weld, in this case check the system for faults and press the reset switch to turn the fault signal off

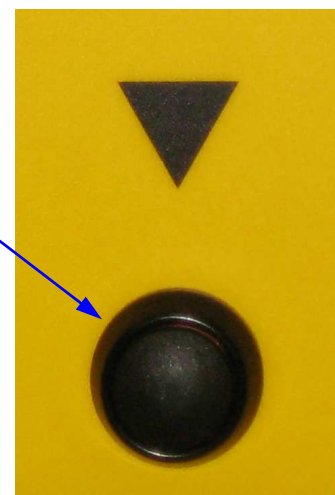

V—3C

EC DECLARATION



This is to certify that the machinery listed below is designed and manufactured in conformance with all applicable health and safety regulations.

This statement is invalid if any modifications are carried out on the machinery without the prior written approval of Taylor Studwelding Systems Ltd

Applicable EC guidelines and corresponding standards:

Low voltage guideline 2006/95/EC:

EN60204-1 Safety of machinery - Electrical equipment of machines

EMC guidelines 2004/108/EC (electromagnetic compatibility):

EN50081 Electromagnetic compatibility - Generic emission standard

EN50082 Electromagnetic compatibility - Generic immunity standard

EN50199 Electromagnetic compatibility (EMC) Product standard for Arc welding equipment

Machine guidelines 2006/42/EC:

EN60974-1 Arc welding equipment: Electromagnetic compatibility (EMC) requirements

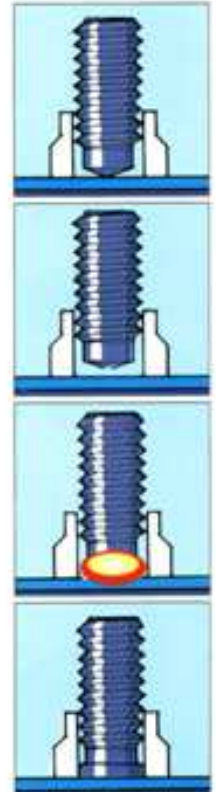

Signed

A handwritten signature in black ink, appearing to read 'D. Taylor'.

D. Taylor
Managing Director



A TAYLORMADE AUTOFEED STUDWELDING SYSTEM FOR CD AND SHORT CYCLE STUDS