

# TAYLOR STUDWELDING SYSTEMS LIMITED



## OPERATING GUIDE

FOR

# TYPE 800E

## DRAWN ARC CONTROLLER

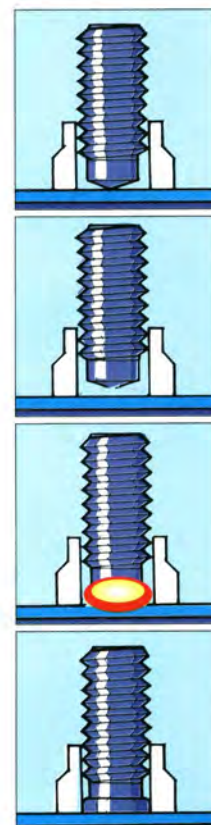

# **INDEX**

## PAGE No. CONTENT

3	USEFUL INFORMATION.
5	IMPORTANT SAFETY INFORMATION.
7	INTRODUCTION TO STUDWELDING.
8	GUIDE TO EXTERNAL FEATURES.
11	SETTING UP AND WELDING.
15	WELDING TIME AND CURRENT SETTINGS.
16	VISUAL WELD INSPECTION.
17	WELD TESTING.
20	STUDWELDING TECHNIQUES.
23	PARTS LIST & EXPLODED DIAGRAMS.
30	PCB'S - LED GUIDE.
31	CIRCUIT SCHEMATIC.
32	ACCESSORIES.
33	EC DECLARATION OF CONFORMITY.

## USEFUL INFORMATION

### MANUFACTURERS DETAILS

TAYLOR STUDWELDING SYSTEMS LIMITED  
COMMERCIAL ROAD  
DEWSBURY  
WEST YORKSHIRE  
WF13 2BD  
ENGLAND

TELEPHONE : +44 (0)1924 452123  
FACSIMILE : +44 (0)1924 430059  
email : sales@taylor-studwelding.com  
WEB : www.taylor-studwelding.com

SALES DIRECT TEL : +44 (0)1924 487703  
TECHNICAL HELPLINE : +44 (0)1924 487701

You may wish to record the details of your controller below as this information will help with any technical assistance you may require:

<b>CONTROLLER SERIAL No.</b>	
<b>DATE PURCHASED.</b>	

### PURPOSE AND CONTENT OF THIS GUIDE

This guide has been written for :

- The personnel of the end-user responsible for the installation and maintenance of the controller.
- The operator of the welding controller.

This guide contains information relating to :

- Installation and connection.
- Operation.
- Technical specifications and parameters.
- Spare parts.

# USEFUL INFORMATION

## FURTHER INFORMATION

Should you require additional technical information, please contact us directly (details on previous page) or our local agent / distributor (details of agents etc. can be obtained from us).

This guide contains important information which is a pre-requisite for safe Operation of the equipment. The operating personnel must be able to consult this guide when necessary. In the interests of safety, make this guide available to your personnel in good time.

If the equipment is sold / passed on, please hand over this manual to the new owner and if possible please inform us of the name and address of the new owner, in case we need to contact him regarding the safety of the machine.



PLEASE READ THIS GUIDE CAREFULLY BEFORE INSTALLING OR OPERATING THE CONTROLLER.



PLEASE OBSERVE CAREFULLY ALL SAFETY PROCEDURES/INSTRUCTIONS.



DUE TO THE POWER REQUIREMENTS AND ELECTROMAGNETIC EMISSIONS PRODUCED DURING NORMAL USE, THIS MACHINE MUST ONLY BE OPERATED IN AN INDUSTRIAL ENVIRONMENT.



THIS MACHINE OPERATES FROM A MAINS SUPPLY OF 380/415V AC @ 50/60 Hz



NEVER REMOVE ANY PORTION OF THE UNIT HOUSING WITHOUT FIRST ISOLATING THE CONTROLLER FROM THE MAINS ELECTRICAL SUPPLY.



NEVER OBSTRUCT THE UNDERSIDE, FRONT OR REAR PANELS AS THIS MAY CAUSE THE UNIT TO OVERHEAT DURING OPERATION.



DO NOT USE THIS WELDING POWER SOURCE FOR PIPE THAWING.



THIS EQUIPMENT HAS BEEN EMC TESTED AND APPROVED IN ACCORDANCE WITH BS EN 60974-10 (CATEGORY 2).

# **IMPORTANT SAFETY INFORMATION !**

## **PROTECT YOURSELF AND OTHERS !**

Read and understand these safety notes.

### **1. ELECTRICAL**

No portion of the outer cover of the welding controller should be removed by anyone other than suitably qualified personnel and never whilst mains power is connected.

ALWAYS DISCONNECT THE MAINS LEAD BEFORE ATTEMPTING ANY MAINTENANCE.



BEWARE - RISK OF ELECTRIC SHOCK !

Do not use any fluids to clean electrical components as these may penetrate into the electrical system.

Installation must be according to the setting up procedure detailed on page 11 of this guide and must be in line with national, regional and local safety codes.

### **2. FIRE**

During welding small particles of very hot metal are expelled. Ensure that no combustible materials can be ignited by these.

### **3. PERSONNEL SAFETY**

Arc rays can burn your eyes and skin and noise can damage your hearing. Operators and personnel working in close proximity must wear suitable eye, ear and body protection.

Fumes and gases can seriously harm your health. Use the equipment only in a suitably ventilated area. If ventilation is inadequate, then appropriate fume extraction equipment must be used.

Hot metal spatter can cause fire and burns. Appropriate clothing must be worn. Clothing made from, or soiled with, combustible materials must NOT be worn.

Have a fire extinguisher nearby and know how to use it.

Magnetic fields from high currents can affect heart pacemakers or other electronically controlled medical devices. It is imperative that all personnel likely to come into the vicinity of any welding plant are warned of the possible risks before entering the area.

### **4. MAINTENANCE**

All cables must be inspected regularly to ensure that no danger exists from worn or damaged insulation or from unsound electrical connections. Special note should be made of the cables close to the pistol, where maximum wear occurs. As well as producing inconsistent welds, worn cables can overheat or spark, giving rise to the risk of fire.

# **IMPORTANT SAFETY INFORMATION !**

## **5. TRAINING**

Use of the equipment must be limited to authorised personnel only who must be suitably trained and must have read and understood this manual. This manual must be made available to all operators at all times. Further copies of this manual may be purchased from the manufacturer. Measures must be taken to prevent the use of this equipment by unauthorised personnel.

## **6. LIMITATIONS OF USE**

The mass of the welding controller is 98kg and not suitable for man lifting. It is fitted with suitable castors to enable man powered movement on flat, level, smooth surfaces only. The welding controller is also fitted with appropriate lifting points to allow lifting by crane/ forklift truck. The controller is not suitable for use in rain or snow or in an environment with increased risk of electric shock.

## **7. INSTALLATION**

Ensure that the site chosen for the equipment is able to support the weight of the equipment and that it will not fall or cause a danger in the course of its normal operation. Do not hang connecting cables over sharp edges and do not install connecting cables near heat sources or via traffic routes where people may trip over them or they may be damaged by the passage of vehicles (forklifts etc).

## **8. INTERFERENCE**

During welding operations, intense magnetic and electrical fields are unavoidably produced which may interfere with other sensitive Electronic equipment. All Taylor Studwelding equipment is designed, manufactured and tested to conform the current appropriate European standards and directives regarding electromagnetic emissions and immunity and as such is safe to use in any normal environment.

## **9. DISPOSAL**

The equipment either wholly or any of its component parts may be disposed of as part of general industrial waste or passed to a scrap merchant. None of the components used in the manufacture are toxic, carcinogenic or harmful to health in their "as supplied" condition.

## **INTRODUCTION TO STUDWELDING**

The Taylor Studwelding 800E Drawn Arc controller when matched with an appropriate pistol and earth cables is intended for precision stud welding up to 12 mm diameter reduced base studs. The controller is easily transportable and has been designed to operate with a minimum amount of maintenance.

The energy required to carry out the welding operation is derived from a fully micro-processor controlled transformer-rectifier inside the controller.

Taylor Studwelding Systems Ltd pistols are modern, ergonomically designed and offer maximum comfort in handling with minimum operator fatigue.

### **THE PROCESS**

The process of drawn arc studwelding is long established and well proven. The basic steps are as follows :

- A measured amount of weld stud protrusion is set at the welding pistol.
- Once in position, the pistol lifts the stud away from the work-piece, simultaneously striking an arc between the two.
- Both the tip of the weld stud and the surface of the work-piece melt as the arc is sustained for a pre-determined interval.
- At the completion of the pre-determined interval, the pistol returns the weld stud to the molten pool on the work-piece, thus forming a weld.

The most common and traditional drawn arc welds have a weld duration greater than 100ms and employ the use of a single use ceramic arc shield, commonly referred to as a ferrule. This ferrule helps to protect the arc during the weld and assists in formation of the final fillet. Post welding the ferrule is removed and disposed of.

It is possible to stud weld without a ferrule. This method is more commonly employed with welds having a duration of less than 100 ms and this type of weld is referred to as short cycle stud welding. Although no ferrule is employed, it is recommended practice in short cycle welding to employ a suitable shielding gas to reduce the amount of porosity in the completed weld and improve weld quality.

# GUIDE TO EXTERNAL FEATURES

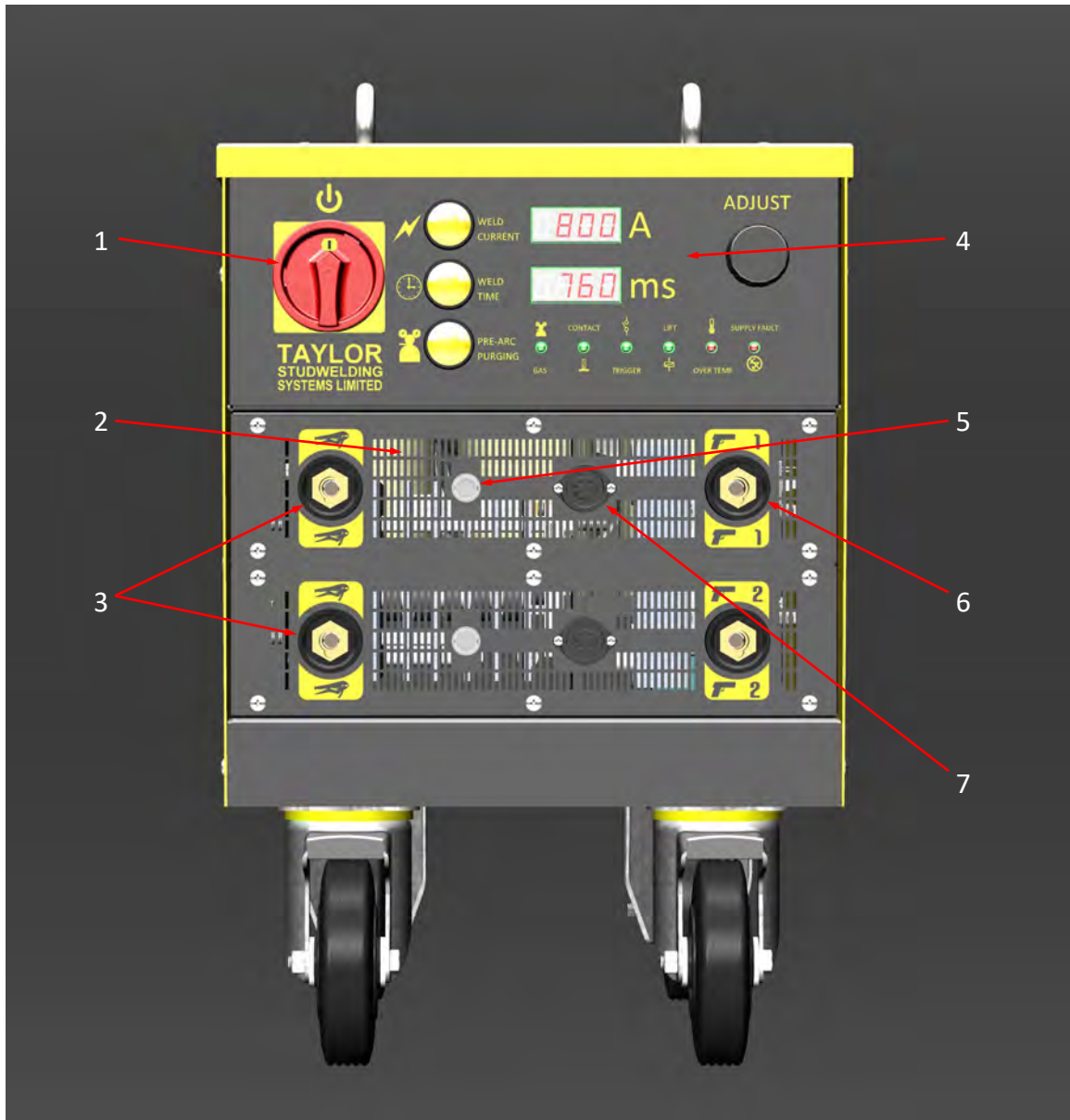

## FRONT PANEL

1. MAINS ON/OFF SWITCH
2. VENTILLATION HOLES
3. WELDING EARTH CONNECTION SOCKET(S)
4. CONTROL PANEL
5. SHIELDING GAS OUTLET SOCKET
6. PISTOL WELDING CONNECTION SOCKET

**! DO NOT OBSTRUCT !**

SEE PAGE 9



# GUIDE TO EXTERNAL FEATURES

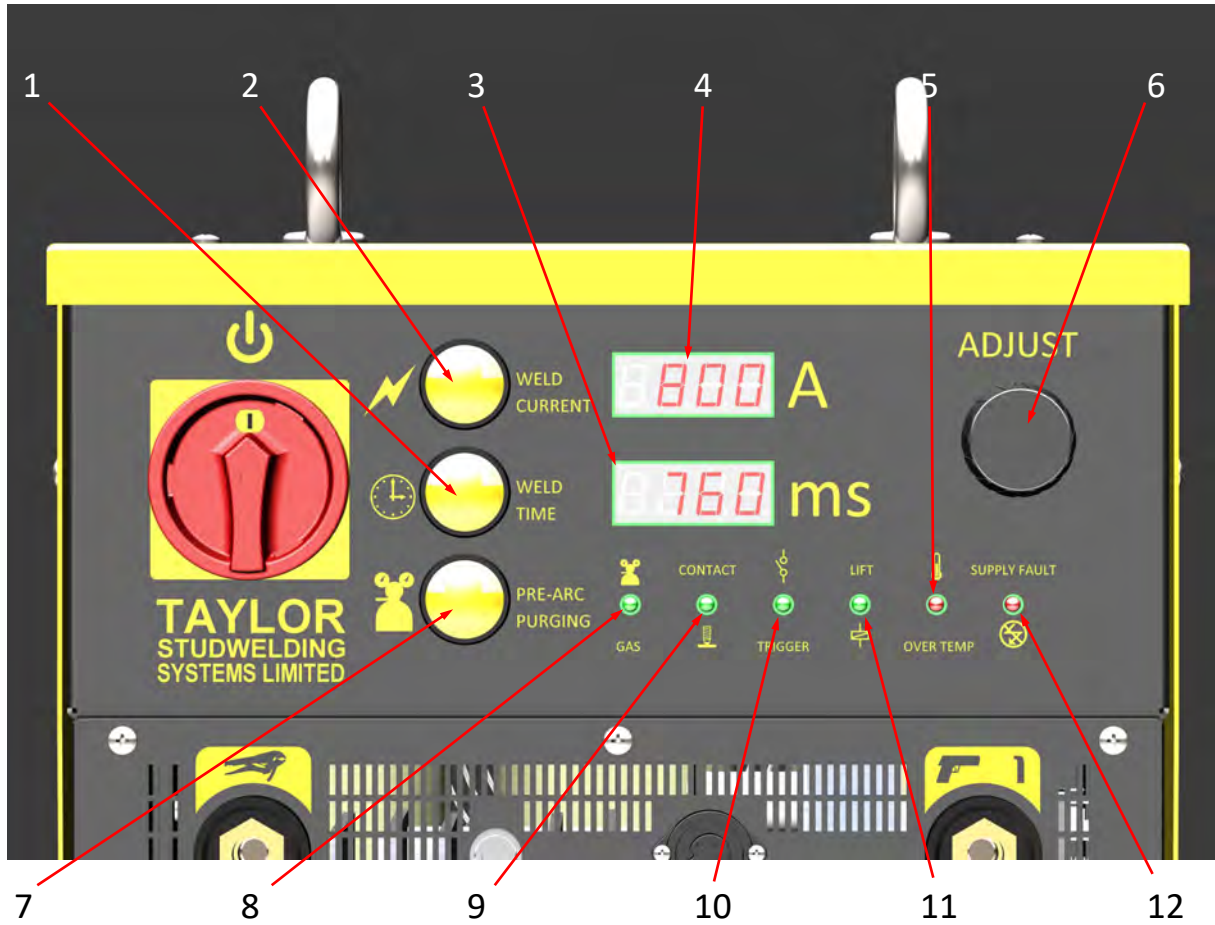

## CONTROL PANEL

1. WELDING TIME SETTING PUSHBUTTON
2. WELDING CURRENT SETTING PUSHBUTTON
3. WELDING TIME/GAS PURGE TIME DISPLAY WINDOW
4. WELDING CURRENT DISPLAY WINDOW
5. CONTROLLER OVER TEMPERATURE INDICATOR - RED
6. ADJUSTER KNOB
7. GAS PURGE TIME SETTING PUSHBUTTON
8. GAS FLOWING INDICATOR - GREEN
9. STUD TO WORKPIECE CONTACT INDICATOR - GREEN
10. PISTOL TRIGGER ACTUATED INDICATOR - GREEN
11. PISTOL LIFT COIL ENERGISED INDICATOR - GREEN
12. SUPPLY FAULT INDICATOR - RED

## GUIDE TO EXTERNAL FEATURES

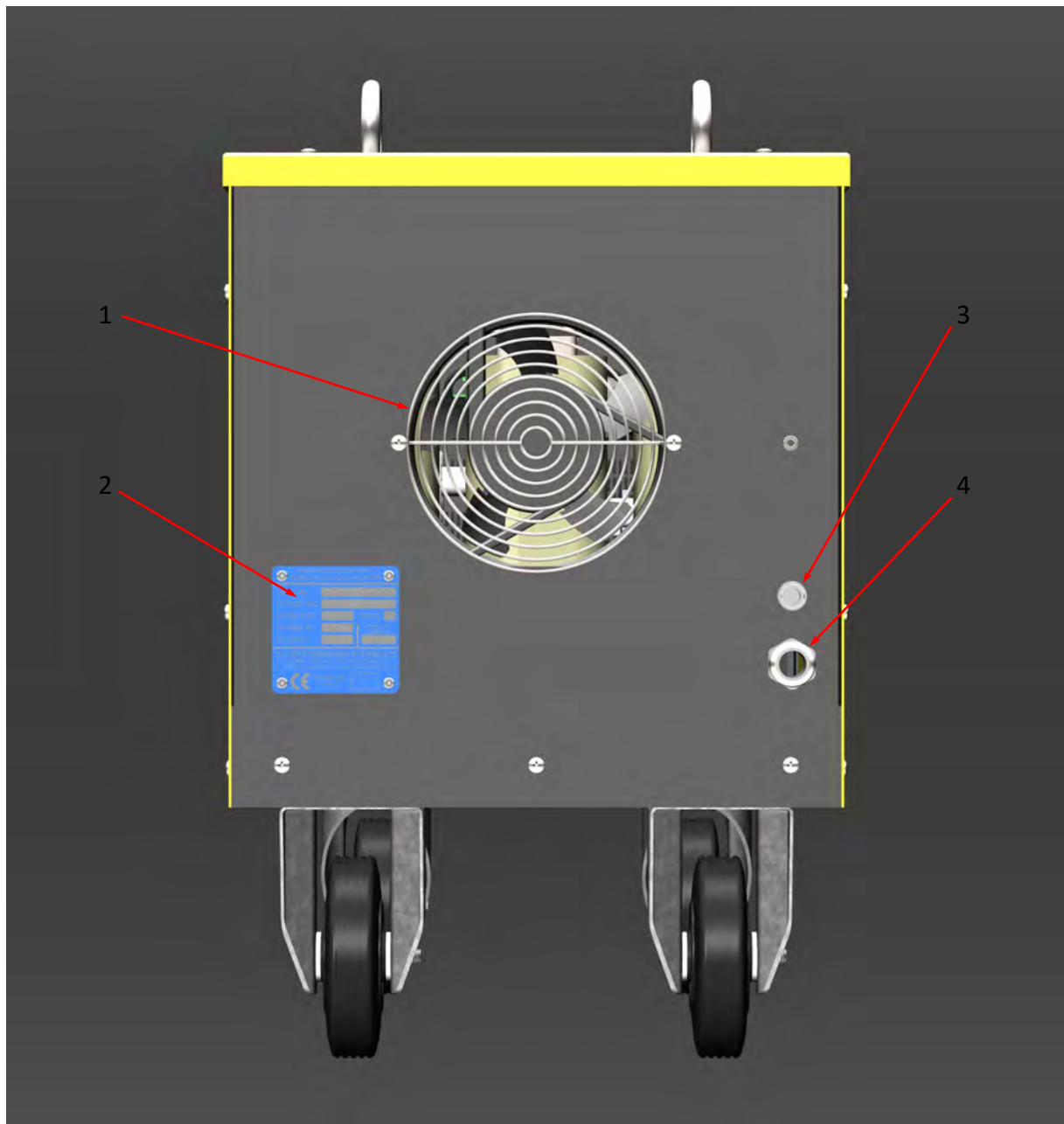

### BACK PANEL

1. VENTILLATION GRILLE
2. RATING/SERIAL PLATE
3. SHIELDING GAS INLET
4. 3 Ph MAINS CABLE INLET GLAND

**! DO NOT OBSTRUCT !**

# SETTING UP AND WELDING

Set up the control unit at the place of work, ensuring that the mains switch is in the OFF position.

Plug the controller into a suitable three phase AC supply with a 32A motor rated fuse/breaker.

Plug the welding earth cables into the controller. Note that the cable end weld plug has a peg which mates with the key slot in the panel mounted socket.

**IMPORTANT!** Secure the connectors with a clockwise turn until they lock. Failure to do this may result in damage to the connectors during welding.

Attach the welding earth clamps to the work piece at approximately 180° to each other; this will help prevent "arc-blow" when welding takes place. Prior to fitting the clamps, ensure that the contact area of the work piece is free from rust, paint, grease etc., as this will result in a poor welding connection.

Plug the welding pistol cable into the controller. Note that the cable end weld plug has a peg which mates with the key slot in the panel mounted socket.

**IMPORTANT!** Secure the connectors with a clockwise turn until they lock. Failure to do this may result in damage to the connectors during welding.

Plug the pistol control cable into the controller. Note that the cable end plug and panel-mounting socket are keyed to prevent incorrect fitting. Push the plug firmly home and twist the locking ring to secure the plug in position.

Set up the welding pistol according to the instructions in the operating guide supplied with the pistol.

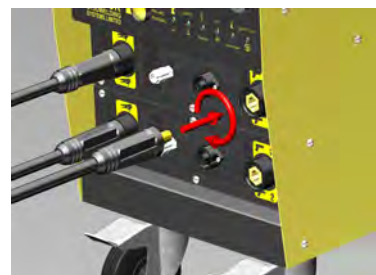

## SETTING UP AND WELDING

Switch the controller ON by turning the mains switch clockwise through 90°. The ventilation fans will start, the display will illuminate and carry out a start up diagnostic routine. This will take approx' 6 seconds at the end of which the display will indicate the current settings of the last pistol used.



A guide to the recommended time and current settings can be found on page 15 of this handbook.

Referring back to the control panel guide on page 9, set the controller by following these simple steps :-

SELECT THE PISTOL TO SET UP.

Having previously connected one or two pistols dependent on controller model to the controller. Firstly select the pistol to be set. To do this, pick up the pistol you want to set up and activate the trigger. The display window (4) will briefly display an identifier for the pistol. From this point, until a trigger is activated on another connected pistol, any setting entered will be for this pistol connected to this port.

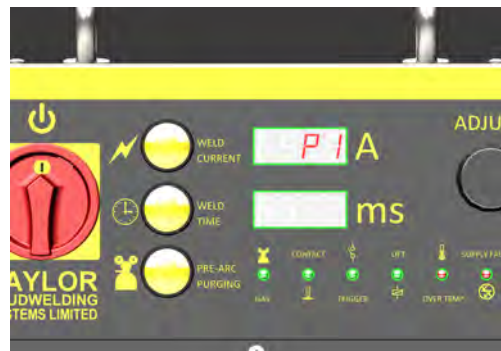

SET WELD CURRENT

1. Press and hold the current setting pushbutton (2). The display window (4) will display the last set current for this pistol and display window (3) will display the pistol identifier.
2. Turn the adjuster knob (6) until the required current is displayed in the welding current display window (4). The current is adjustable between 200 and 800A in increments of 10A.
3. Release the pushbutton (2). The current is now set.



**NOTE!** If the pushbutton (2) is held for more than 3 seconds before turning the adjuster knob (6), the display (4) will change to last weld current readback mode and will need to be released and re-pressed.

# SETTING UP AND WELDING

## SET WELD TIME

1. Press and hold the weld time setting pushbutton (1).
2. Turn the adjuster knob (6) until the required time is displayed in the display window (3). The time is adjustable between 20 and 2000ms in 5ms increments up to 100ms and 10ms increments thereafter.
3. Release the pushbutton (1). The weld time is now set.



NOTE! If the pushbutton (1) is held for more than 3 seconds before turning the adjuster knob (6), the display (3) will change to last system error code display mode and will need to be released and re-pressed.

## SETTING THE GAS PURGE TIME

1. Press and hold the shielding gas purge time setting pushbutton (7).
2. Turn the adjuster knob (6) until the required time is displayed in the time display window (3). The time is adjustable between 0 and 5000ms in 100ms increments.
3. Release the pushbutton (7). The shielding gas purge time is now set.
4. If no gas purge is required, this time parameter must be set to 0 (zero).



NOTE! If the pushbutton (7) is held for more than 3 seconds before turning the adjuster knob (6), the display (3) will change to display feedback system parameters (not operator adjustable) and will need to be released and re-pressed.

Repeat these steps from “SELECT THE PISTOL TO SET UP” on the previous page for any additional pistols connected to the controller.

NOTE! Changing pistols over from one port to another will not carry the settings over and the pistol will require re-setting in-line with these steps.

## SETTING UP AND WELDING

Place the pistol perpendicular to the work piece with the stud touching down at the desired location to be welded. Press down on the pistol until the ceramic ferrule rests firmly on the work piece. Press the trigger to initiate the weld sequence.

See the section on Studwelding Techniques for further advice.

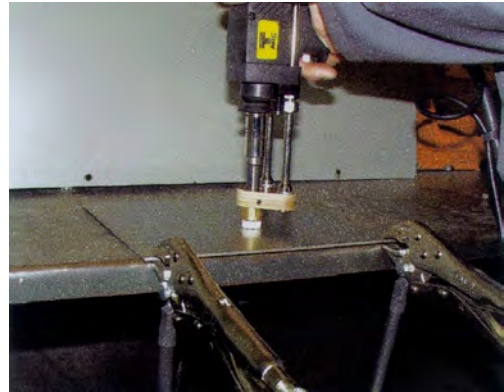

The welding process is as follows: -

1. Start.
2. Pistol lifts stud.
3. Pilot Arc strikes.
4. Main Arc strikes melting both stud and workpiece.
5. Arc stops. Pistol plunges stud into molten pool.
6. Weld complete.

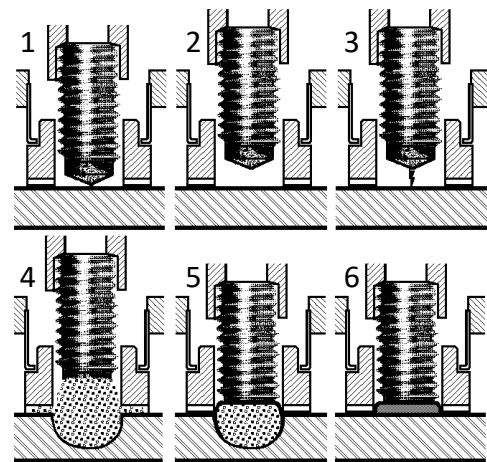

Having welded the stud, draw the pistol vertically off the stud. Failure to do this may cause the split tines of the chuck to splay out. This will result in the chuck and stud arcing together during subsequent welds.



Finally, remove the ferrule by lightly tapping until it shatters. Visually inspect the weld.

For a guide to the inspection of the welded stud see the sections on Inspecting and Testing Welded Studs.



# WELDING TIME AND CURRENT SETTINGS

This page is intended as a guide to setting your machine.

A set of basic formulae as defined by the British Standard BS EN ISO 14555:2014 (European Standard EN ISO 14555:2014) Annex A.2.7.2.2 and Annex A.2.7.2.4 may be used to calculate the current and time settings to weld any stud.

These formulae when applied to standard studs give results shown in the table on this page. A graphical representation of the data is also illustrated below.

STUD TYPE	ACTUAL DIAMETER (mm)	WELD CURRENT (A)	WELD TIME (ms)
5FB	5	400	100
6RB	4.7	376	94
6FB	6	480	120
8RB	6.2	496	124
8FB	8	640	160
10RB	7.9	632	158
10FB	10	800	200
12RB	9.5	760	190

The settings generated in the table are only intended as a starting point. It is possible that the settings will give satisfactory results without adjustment, but in reality the quality of the welding results is governed by many variable factors. These include, most obviously, the welding time, current and arc-gap (pistol lift) as covered in the table, but can also include factors such as stud and work-piece material type and condition, ambient temperature, relative humidity, quality of supply etc. All of these factors can act on the weld to change the outcome. It is recommended that in all instances, you need to carry out sample welds in your actual conditions and environment. This will enable you to alter the settings, where necessary, to achieve welds that are most acceptable to you.

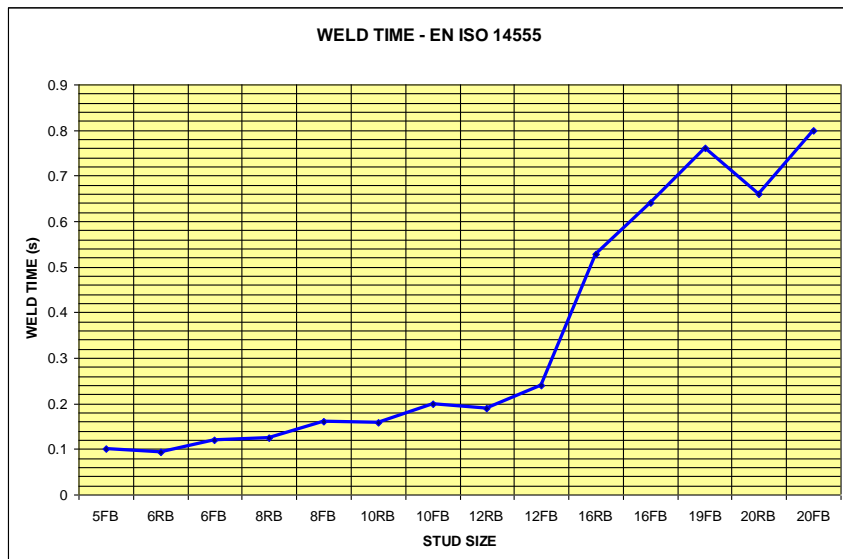
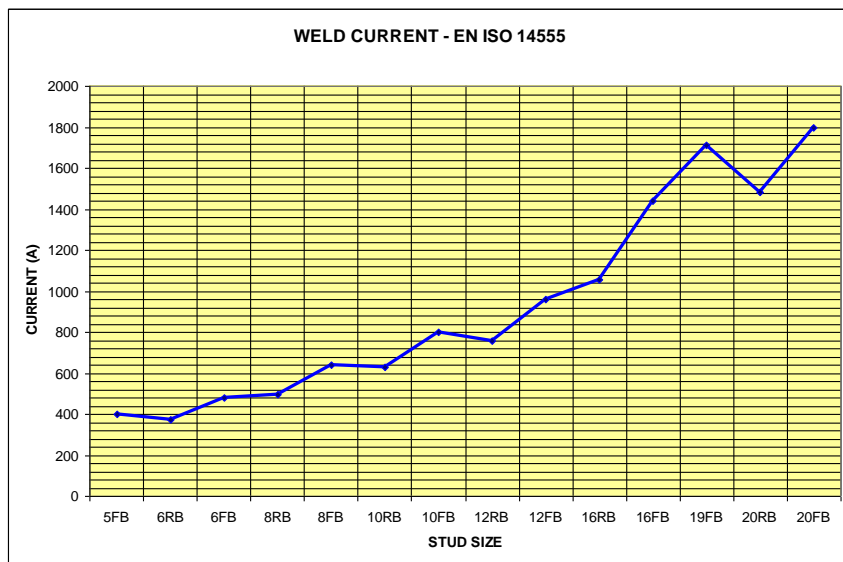

# VISUAL WELD INSPECTION

This page will help you to recognise a poor weld when you see one and give some of the possible explanations as to how it may have occurred. Your test welds should look like the first example diagram in the series and once you transfer to the actual job, periodic checks should be made to ensure that your welding is consistently good.

## **POINTS TO LOOK FOR IRRESPECTIVE OF PROCESS USED.**

- L.A.W. (Length After Welding). This should be correct to within + 0 / - 1 mm.
- The base fillet of the welded stud is complete.
- The welded stud is perpendicular to the work-piece.

## **WHEN USING A CERAMIC FERRULE.**

This diagram is an example of a good normal weld, fulfilling the criteria above i.e. The LAW is correct, the stud has a complete, well formed and even fillet and is also perpendicular to the work-piece.

The following examples will help you to recognise the most common types of poor weld, explain the possible causes of these problems and how to remedy them.

### **EXAMPLE 1**

**PROBLEM :** Insufficient heat, causing the L.A.W. to be too long and the fillet to be underdeveloped and/or incomplete.

**REMEDY :** Increase the welding time (see page 12).

### **EXAMPLE 2**

**PROBLEM :** Excessive heat, causing the L.A.W. to be too short and the fillet to be too large and messy, spreading out under the ferrule and/or splashing up the threads.

**REMEDY :** Reduce the welding time (see page 12).

### **EXAMPLE 3**

**PROBLEM :** The ferrule is not being held firmly against the work-piece and/or the stud is binding against the ferrule.

**REMEDY :** Hold the pistol firmly down to the work-piece (see page 14) and reset the alignment of the stud and ferrule (refer to your pistol setup guide).

### **EXAMPLE 4**

**PROBLEM :** Insufficient stud protrusion set on the pistol and/or the stud is binding against the ferrule.

**REMEDY :** Adjust stud protrusion to correct setting (refer to your pistol setup guide).

### **EXAMPLE 5**

**PROBLEM :** Poor alignment i.e. stud is not perpendicular to the work-piece.

**REMEDY :** Hold the pistol perpendicular to the work-piece (see page 14).

**NOTE :** If the misalignment is only slight and in all other aspects the weld is good, then the weld may be salvaged by tapping straight with a soft mallet.

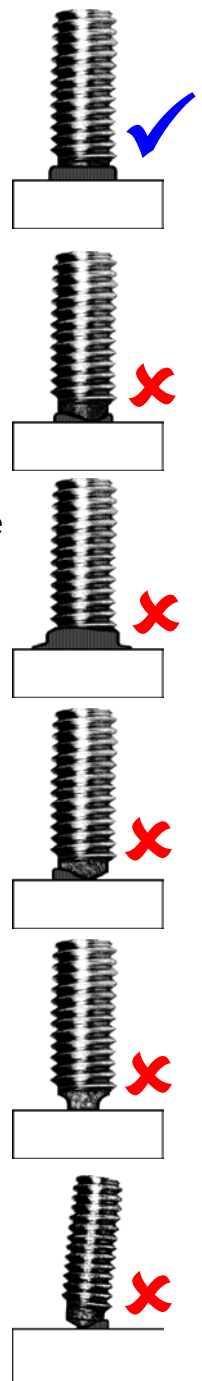



## **WELD TESTING**

There are two factors which should receive special attention in establishing visually whether or not a stud weld is sound. These are :

- The length after weld (L.A.W.) of the stud should be correct. That is to say that a stud which is intended to be 50 mm long after welding, should be correct within +0/-1 mm. A word of explanation is perhaps needed on this point. All studs produced include a "weld allowance". This allowance is so arranged for the different diameters of stud, that it will be completely melted during the welding process, provided of course that the correct conditions have been established and the correct values of current and time are used.
- The fillet of metal formed around the base of the stud should be well formed, reasonably evenly distributed, completely free from blow holes and of a silver blue colour.

These two factors combined form the basis of all visual stud weld examination. It should be the aim of every operator to produce these results.

Under normal conditions a stud welded to clean mild steel plate of adequate thickness having the correct L.A.W. and fillet formation, as described above, will be a satisfactory weld.

It should be remembered, however, that different applications or conditions will produce slightly different visual results, particularly in the appearance of the fillet, i.e.. Slightly rusty, dirty or oily plate will produce blow holes in the fillet, in proportion to the degree of plate contamination. Welding close to some magnetic obstruction may produce uneven fillet distribution. Too much power will produce a fillet that flows too easily and is lost either up in the threads of the stud or out through the ferrule vents, while too little power may not melt sufficient material to form a complete fillet.

It is important, therefore, to judge the degree to which these possible variations will affect the weld strength, but in general, provided that the L.A.W. is correct and the fillet formation is not unsightly, a visual examination is all that is required.

Further testing may be carried out on a "percentage of production" basis, and the methods used fall into the classes outlined below.

### **1. DESTRUCTIVE TESTING.**

Should only be used on studs welded to samples and test pieces.

- Hammering a stud over may look spectacular, but it is not a satisfactory test, as the direction and force behind the blows is uncontrolled, as also is the point at which the impact takes place. The length, diameter and type of stud also have an effect on the results obtained.
- Bending the stud over by using a tube of approximately the same bore as the stud diameter. This method is preferred to hammering, but again no conclusive evidence as to the strength of the weld is obtained.
- Loading the stud by the use of washers / spacer and a nut until the stud breaks. This method is much more conclusive and should show that the weld is in fact stronger than the stud. Use of a suitably calibrated torque wrench for this test will give an indication of the U.T.S. developed by the stud material under test.

# WELD TESTING

## 2. NON DESTRUCTIVE TESTING.

Generally the most practical way of testing threaded stud welds, without destroying the stud, is with the use of proof tests. A torque wrench is particularly useful for this purpose.

Below and overleaf are some tables which you may find useful. However, it must be noted that :

- Formulas & data shown are intended for guidance only.
- In applications where control of preload is important, the torque - tension relationship should be determined experimentally on the actual parts involved including any lubricants.
- The coefficient of friction (k) varies with material, surface finish and lubricity of threads and bearing areas of fastened parts.
- For standard steel screws it is 0.19 to 0.25 and 0.13 to 0.17 for plated screws. Anti-seize materials and lubricants can lower k to 0.05. For some stainless steel threads and parts not coated or lubricated k may be as high as 0.33
- All the figures are approximate and do not form part of any specification.
- Designers and specifiers must satisfy themselves that the studs and materials chosen are suitable for their particular application.

Material properties:	(N/mm <sup>2</sup> )	(N/mm <sup>2</sup> )	(N/mm <sup>2</sup> )
	UTS	Yield	Safe
Mild Steel (4.8)	420	340	272
Stainless Steel (1.4301)	540	350	280
Note: safe loads are 80% of the yield			

All torque figures are calculated by the formula :  $T = kDP$

Where :  $T = \text{Torque (Nm)}$   
 $D = \text{Effective Stud Diameter (m)}$   
 $k = \text{Coefficient of Friction (0.2 used for calculations)}$

## **WELD TESTING**

Stud loads - Full Base Drawn Arc Studs (kN)

	Mild Steel	Mild Steel	Mild Steel	Stainless Steel	Stainless Steel	Stainless Steel
Thread	UTS	Yield	Safe	UTS	Yield	Safe
M5 x 0.8	5.8	4.7	3.7	7.4	4.8	3.8
M6 x 1.0	8.2	6.6	5.3	10.6	6.8	5.4
M8 x 1.25	15.2	12.3	9.8	19.6	12.7	10.1
M10 x 1.5	23.8	19.2	15.4	30.6	19.8	15.8
M12 x 1.75	34.6	28.0	22.4	44.5	28.8	23.1

Torque required to reach the loads above (Nm)

	Mild Steel	Mild Steel	Mild Steel	Stainless Steel	Stainless Steel	Stainless Steel
Thread	UTS	Yield	Safe	UTS	Yield	Safe
M5 x 0.8	4.9	4.0	3.2	6.3	4.1	3.3
M6 x 1.0	8.2	6.7	5.3	10.6	6.9	5.5
M8 x 1.25	20.7	16.8	13.4	26.7	17.3	13.8
M10 x 1.5	40.5	32.8	26.2	52.1	33.8	27.0
M12 x 1.75	71.0	57.5	46.0	91.3	59.2	47.4

Stud loads - Reduced Base drawn Arc Studs (kN)

	Mild Steel	Mild Steel	Mild Steel	Stainless Steel	Stainless Steel	Stainless Steel
Thread	UTS	Yield	Safe	UTS	Yield	Safe
M6 x 1.0	7.2	5.8	4.7	9.3	6.0	4.8
M8 x 1.25	12.6	10.2	8.2	16.3	10.5	8.4
M10 x 1.5	20.5	16.6	13.3	26.4	17.1	13.7
M12 x 1.75	29.7	24.0	19.2	38.2	24.8	19.8

Torque required to reach the loads above (Nm)

	Mild Steel	Mild Steel	Mild Steel	Stainless Steel	Stainless Steel	Stainless Steel
Thread	UTS	Yield	Safe	UTS	Yield	Safe
M6 x 1.0	6.8	5.5	4.4	8.8	5.7	4.6
M8 x 1.25	15.7	12.7	10.2	20.2	13.1	10.5
M10 x 1.5	32.5	26.3	21.1	41.8	27.1	21.7
M12 x 1.75	56.6	45.8	36.6	72.7	47.1	37.7

# **STUDWELDING TECHNIQUES**

The operating instructions given previously in this guide apply to the majority of general applications where it is possible to use the pistol in the down hand position and with standard cable lengths. For many applications these conditions do not apply and the following notes will give some guidance as to the methods used to obtain satisfactory results for a variety of applications.

## **1. WELDING TO A PLATE IN THE HORIZONTAL POSITION.**

In this position there is a tendency for the weld metal to run to the underside of the stud during welding, due to the action of gravity, resulting in an uneven fillet. The effect is more noticeable as stud diameter increases and generally speaking it is not recommended that studs of 12 mm diameter and over be welded to vertical plates for this reason. The essential requirement to obtain satisfactory fillet formation is to use the shortest weld time possible with increased welding current. Welding to a vertical surface reduces the maximum size of the stud a given power source will weld. It must be remembered, that greater care is required to ensure that the stud is perpendicular to the work piece. A special tripod foot attachment can be supplied if required. Take particular care to keep the ferrule grip, foot adapter and chuck clean.

## **2. WELDING TO A PLATE IN THE OVERHEAD POSITION.**

**IMPORTANT !** You must protect your face and shoulders with a helmet and cape before carrying out overhead welding operations. Weld spatter can do a lot of damage !

Firstly, obtain satisfactory weld settings in the down hand position before making attempts in the overhead position. Since the weld metal is transferred from stud to plate in small particles in the down hand position, it follows that, when welding overhead, the transfer takes place against gravity. As with vertical welding the best results will be achieved using the shortest possible weld time with increased welding current.

It is important that the ferrule grip, foot adapter and chuck are kept free from spatter build up as this can cause stud return problems or possibly short out/bridge out the weld.

## **3. PISTOL ADJUSTMENTS WHEN WELDING IN THE VERTICAL OR OVERHEAD POSITIONS.**

Problems may be encountered when welding in the vertical or overhead positions with a damped pistol. To prevent problems occurring, where it is possible to do so, the damping effect should be removed or turned off.

Welding can then continue as outlined in sections 1. and 2.

## **4. USING LONG CABLE LENGTHS.**

Frequently the pistol must be used some distance from the nearest available mains supply, for instance on board ship, in power stations and building construction, in workshops building large pre-fabricated structures etc. In these cases long lengths of welding cable are used and it must be realised at the outset that, the longer the cables the smaller the maximum diameter of stud which can be welded with a given power source.

To help get over this problem, if larger diameter studs are to be welded with long lengths of cable, increase the welding cable conductor size.

Try to avoid running the pistol cables and the earth cables alongside each other as this can cause a choking effect, reducing power. Also avoid coiling any excess cable as this will have the same effect.

# **STUDWELDING TECHNIQUES**

## **5. WELDING STUDS LESS THAN 25 mm LONG USING FERRULES.**

As we have seen previously, the stud is held in a recess in the chuck and must be long enough to allow us to set the correct protrusion. A standard chuck has a recess 12 mm deep and ferrules vary in length up to 13.5 mm high. Thus if a stud is much less than 25 mm LAW we shall not be able to obtain the correct protrusion, i.e.. The chuck may hit the ferrule on the return stroke and prevent the stud returning to the plate correctly.

This problem may be overcome by using "shallow recess" chucks (the recess depth is only 6 mm) or if the studs are required to be very short, by using a special type of stud known as a "break-off" type. These studs have an overall LAW of 30 mm and are welded using a standard chuck and ferrule. The stud is "grooved" at the required length from the welding end. After welding, the surplus portion of the stud is broken off with a pair of pliers. By these means, very short studs can easily be welded.

## **6. USING TEMPLATES TO ENSURE POSITIONAL ACCURACY.**

When welding studs around the periphery of a flange, i.e. for cover plates, inspection doors etc., positioning of the studs in relation to each other becomes most important. A simple template made from 2 mm sheet, shaped to suit the component and provided with clamps is usually the answer to this problem. The position of the studs is accurately marked and holes drilled in these positions to accept either the ferrule of the stud to be welded or, if using short cycle, the pistol gas shroud. The size of the holes should be the outside diameter of the ferrule / shroud +0.4 mm. It is also advisable to provide 2 mm thick pads underneath the template so that there is a space between the component and template, this space will allow the gases developed during welding to vent properly from the ferrule / shroud. For any further advice or help in the design of jiggging or templates contact your local field sales engineer.

## **7. MINIMUM PLATE THICKNESSES WHEN STUD WELDING.**

When using standard Drawn Arc with ceramic ferrules, the minimum ratio of stud diameter to plate thickness is 4 : 1 for plate thickness greater than 3 mm and 3 : 1 for plate thickness between 1.5 mm and 3 mm. When using the short cycle system with or without gas purging it is possible to weld equivalent size studs onto slightly thinner sections, due to the short weld duration. These ratios ensure that the strength of the plate is sufficient to support a stud of a given size when it is loaded, without there being a tendency for the plate to distort.

Occasionally, however, it may be necessary to weld a stud outside of these ratios. This can sometimes be accomplished without distortion by "heat sinking" the component, by using a flat copper or water cooled backing piece behind the weld area, to support the plate and assist in dissipating heat quickly.

## **8. WELDING STAINLESS STEEL.**

Austenitic stainless steel studs of the 18/8 g/N : weld decay proof type can be supplied for welding to similar parent material or mild steel. The technique does not differ from that used for mild steel stud welding. There is a tendency with larger diameters of stainless steel studs for metal transfer across the arc to take the form of large particles. If short circuits occur then the arc can be heard to splutter. This may occur with any diameter of stainless steel stud if the lift of the hand tool is not correct. Due to this tendency to transfer in large particles increased lift may be required and time settings should be kept as low as possible.

# **STUDWELDING TECHNIQUES**

## **9. WELDING CLOSE TO CORNERS, FLANGES AND OTHER OBSTACLES.**

When welding close to the edge of a plate, in / on a corner, on long strips of narrow plate etc. An effect known as "arc-blow" occasionally will produce an uneven fillet, in such a fillet, most of the material is blown to one side of the stud. "Arc-blow" is caused by the magnetic forces surrounding the arc being intensified in one direction, due to the presence of an air gap or the proximity of a large mass of magnetic material. It is dependant on a number of factors, size of stud, shape of component, position of earth connection, current density etc. No hard and fast rules can be applied to correct it. The following methods are generally helpful, but if satisfactory results cannot be obtained, our field staff will be pleased to advise you. Check that no other fault is present by welding a few studs on to a test piece and inspecting the fillet formation, before deciding that "arc-blow" is causing the uneven fillet.

"Arc-blow" can sometimes be corrected by placing a block of steel near the position of the weld area, on the opposite side to that at which the fillet has blown. When welding near the edge of a plate, the fillet will be blown towards the general mass of material, i.e.. away from the edge. The block in this case should therefore be placed at the edge the plate, touching it, thus providing a more evenly distributed magnetic field. The earth connection can be located immediately below the position of the stud weld, this latter is not always practicable, since it requires the earth connections to be moved frequently. The use of two earth connections, spaced evenly across the welding area, is also advisable.

# PARTS LIST & EXPLODED DIAGRAM

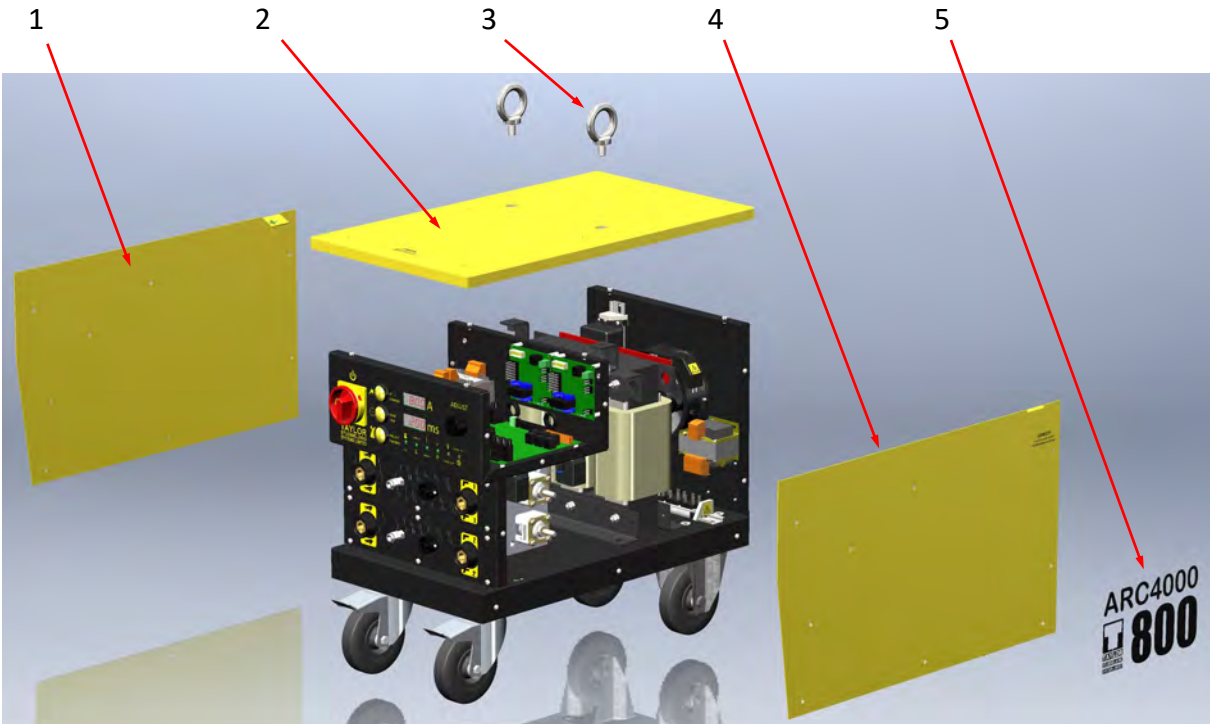

SEE PAGE 24 FOR BREAKDOWN OF CONTROLLER

ITEM	No. OFF	PART No.	DESCRIPTION
1	1	81-113-139	LH SIDE PANEL
2	1	81-113-140	TOP COVER
3	2	81-106-128	LIFTING EYEBOLT
4	1	81-113-138	RH SIDE PANEL
5	2	81-113-141	STICKER

# PARTS LIST & EXPLODED DIAGRAM

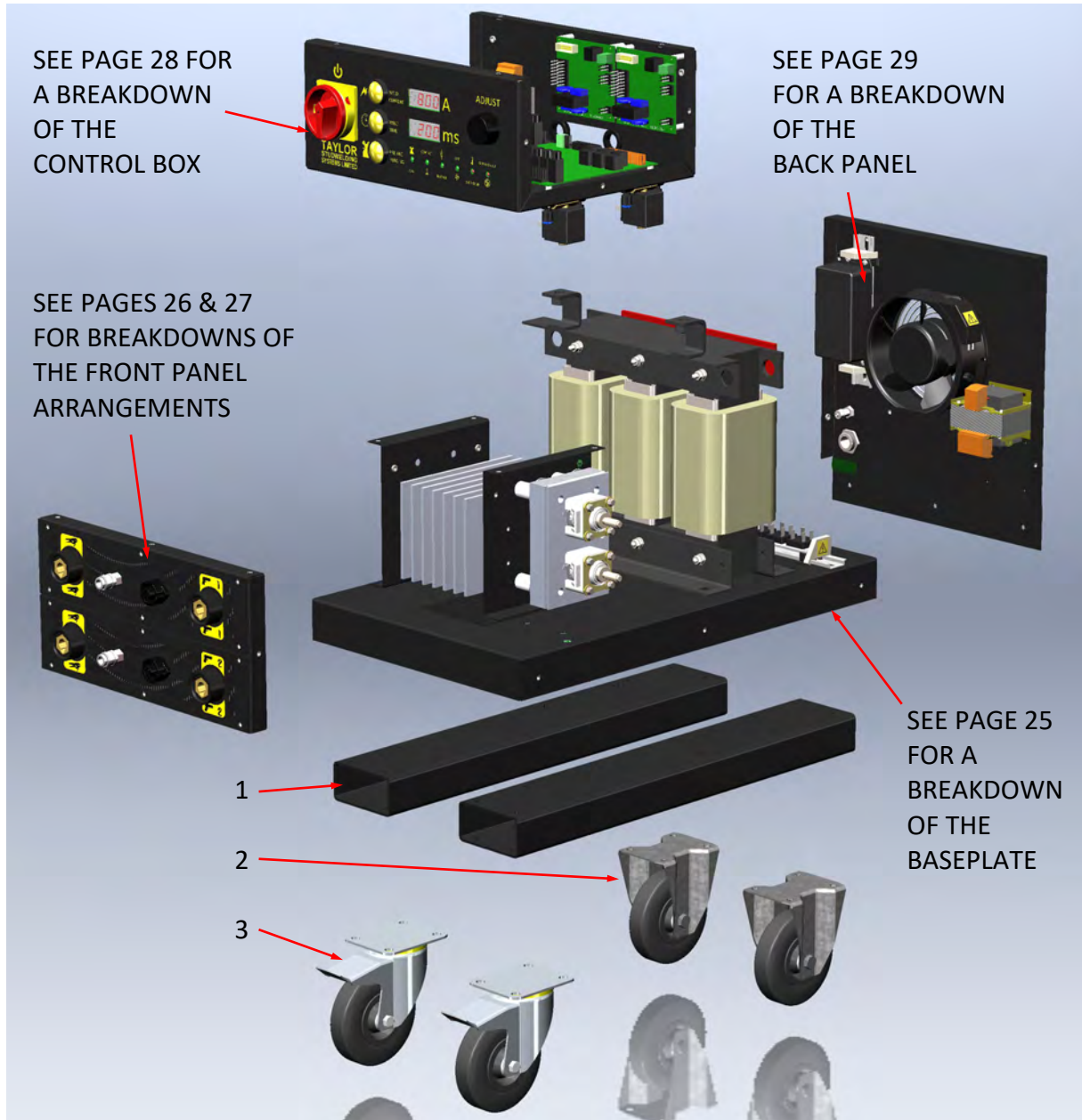

ITEM	No. OFF	PART No.	DESCRIPTION
1	2	81-113-131	SUPPORT TUBE
2	2	81-106-011	CASTOR - FIXED
3	2	81-106-009	CASTOR - SWIVEL & BRAKE



# PARTS LIST & EXPLODED DIAGRAM

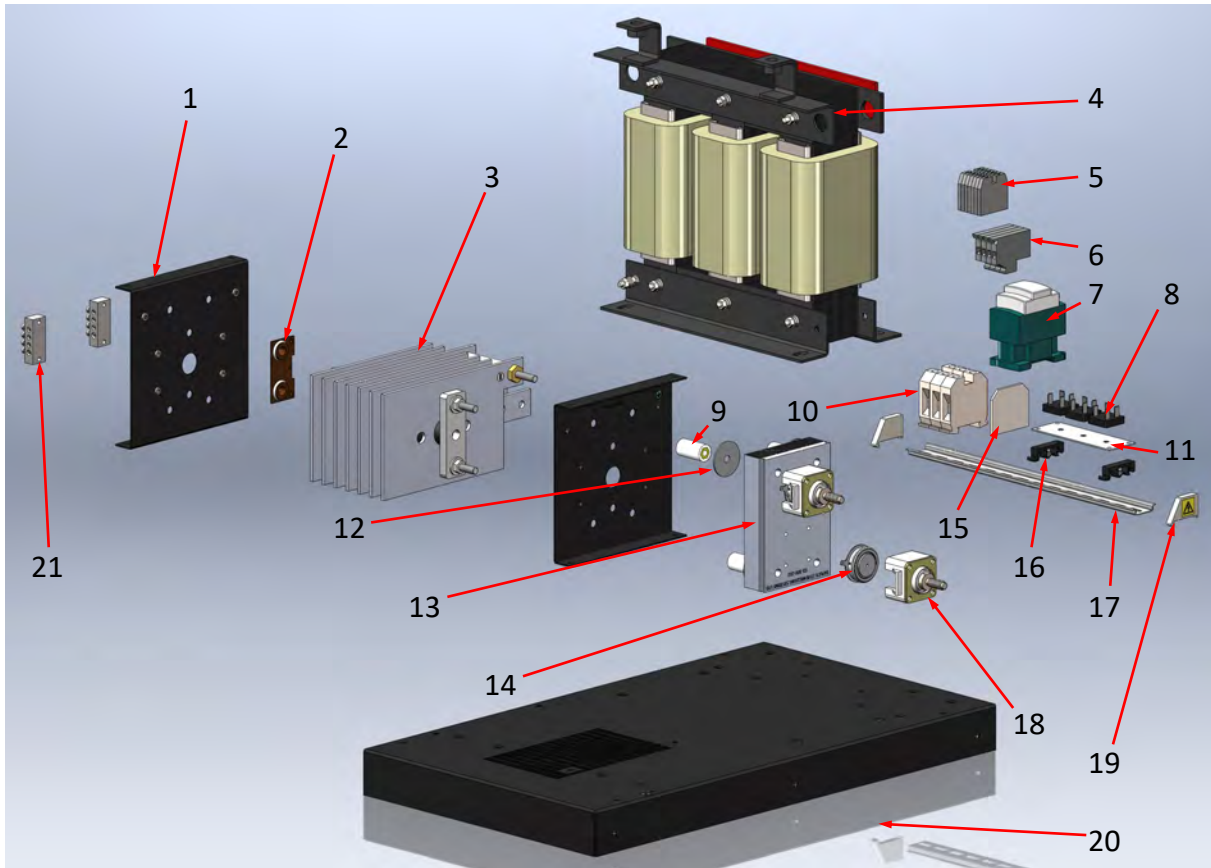

\* ITEMS MARKED THUS ARE ONLY FITTED TO 2 GUN MODELS

ITEM	QTY.	PART No.	DESCRIPTION
1	2	81-113-133	SUPPORT BRACKET
2	1	81-106-195	SHUNT
3	1	81-113-120	RECTIFIER
4	1	81-113-132	TRANSFORMER
5	7	75-101-728	TERMINAL
6	4	81-106-041	FUSEHOLDER
7	1	81-106-071	CONTACTOR
8	3	70-102-100	RECTIFIER
9	4	81-113-021	MOUNT PILLAR*
10	3	81-106-272	TERMINAL

ITEM	QTY.	PART No.	DESCRIPTION
11	1	81-106-298	MOUNT PLATE
12	4	Z600-08-040	WASHER*
13	1	81-106-283	HEATSINK*
14	2	70-102-046	THYRISTOR*
15	1	81-106-273	CLOSURE PLATE
16	2	81-106-275	RAIL MOUNT CLIP
17	1	81-106-051	DIN RAIL
18	2	70-102-047	CLAMP*
19	2	81-106-043	RAIL CLAMP
20	1	81-113-130	BASEPLATE
21	2	70-105-190	EARTH BLOCK

## PARTS LIST & EXPLODED DIAGRAM

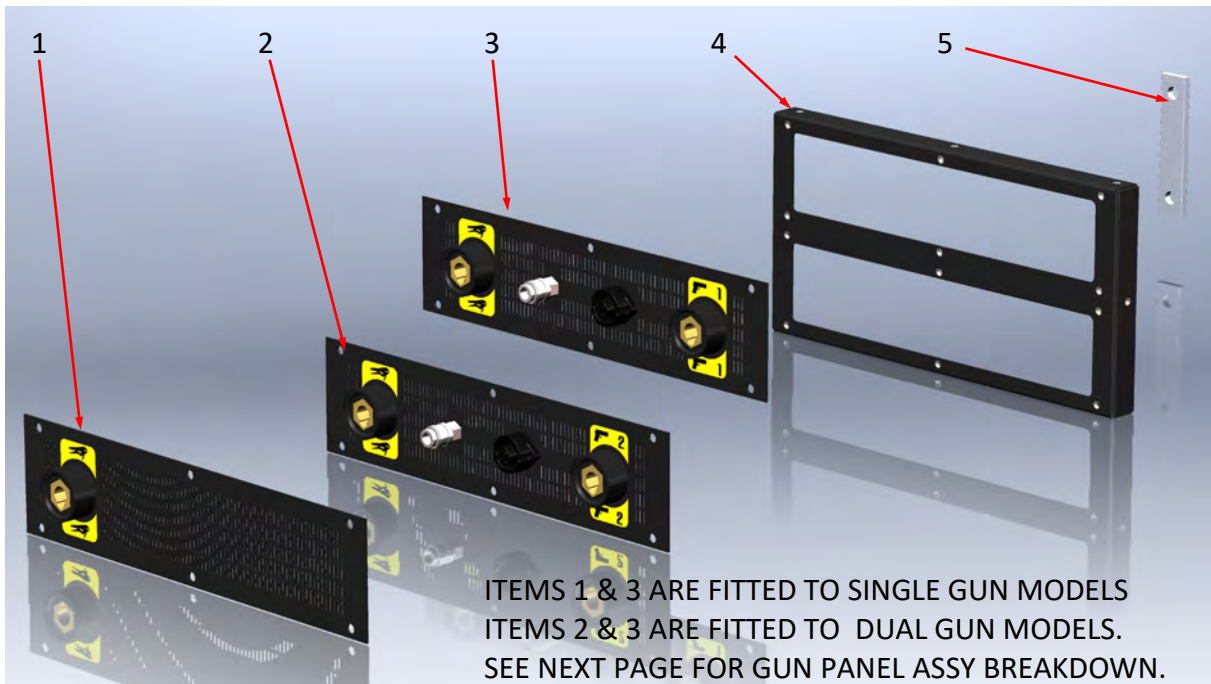

ITEM	No. OFF	PART No.	DESCRIPTION
1	1	SEE BELOW	BLANK PANEL ASSEMBLY
2	1		GUN PANEL ASSEMBLY (GUN 2)
3	1		GUN PANEL ASSEMBLY (GUN 1)
4	1	81-113-134	PANEL MOUNTING FRAME
5	1	81-113-135	BUSBAR
6	1	81-106-031	WELD SOCKET
7	1	81-113-126	BOTTOM EARTH SOCKET STICKER
8	1	81-113-125	TOP EARTH SOCKET STICKER
9	1	81-113-122	BLANK PANEL

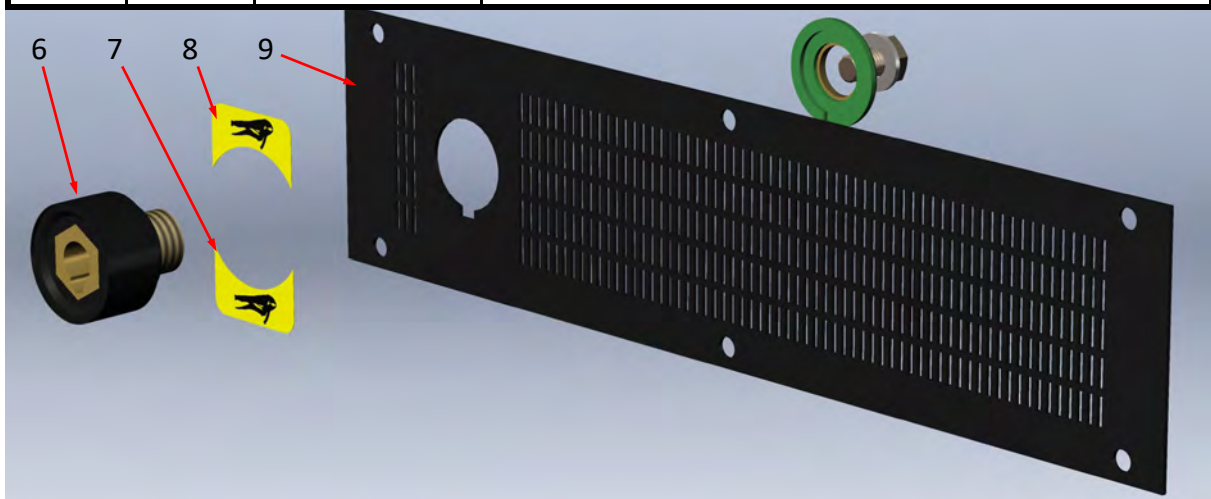

## PARTS LIST & EXPLODED DIAGRAM

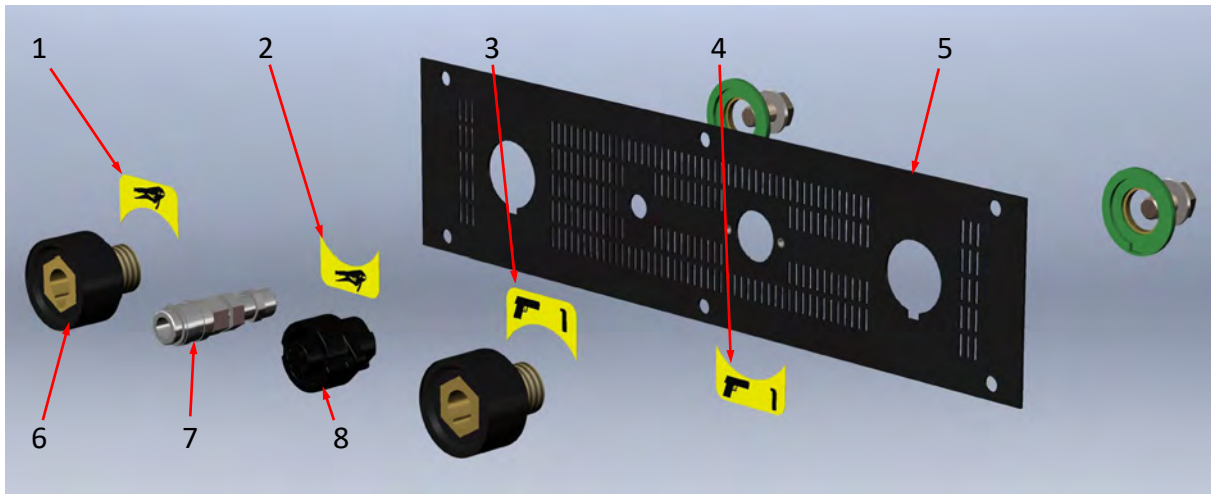

ITEM	No. OFF	PART No.	DESCRIPTION
1	1	81-113-125	TOP EARTH SOCKET STICKER
2	1	81-113-126	BOTTOM EARTH SOCKET STICKER
3	1	81-113-123	TOP GUN 1 SOCKET STICKER
4	1	81-113-124	BOTTOM GUN 1 SOCKET STICKER
5	1	81-113-121	GUN PANEL
6	2	81-106-031	WELD SOCKET
7	1	PFX-CSS-B06-BUL	GAS SOCKET
8	1	70-102-025	CONTROL SOCKET
9	1	81-113-127	TOP GUN 2 SOCKET STICKER
10	1	81-113-128	BOTTOM GUN 2 SOCKET STICKER

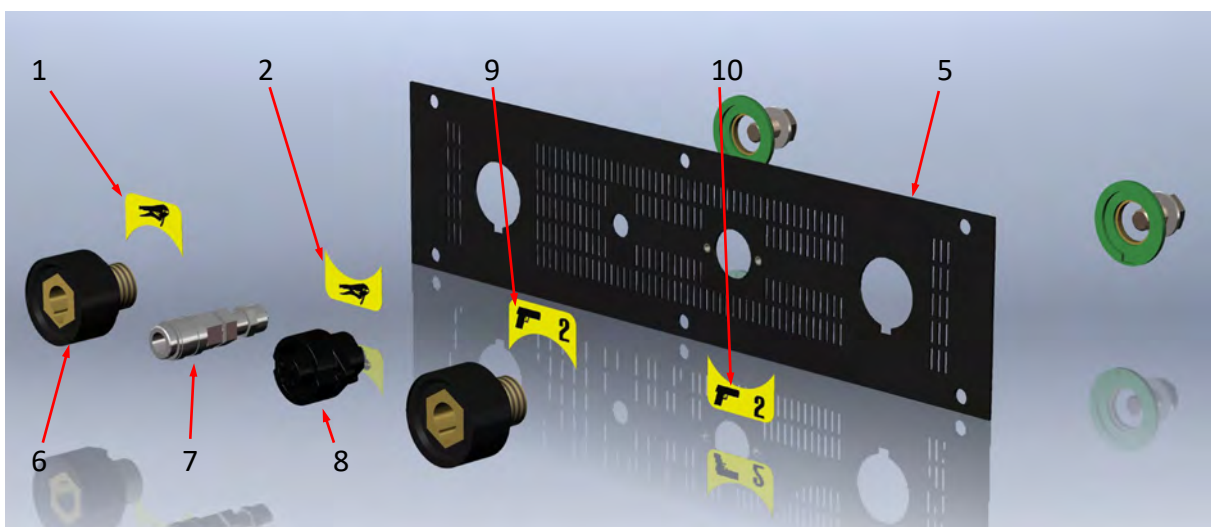

# PARTS LIST & EXPLODED DIAGRAM

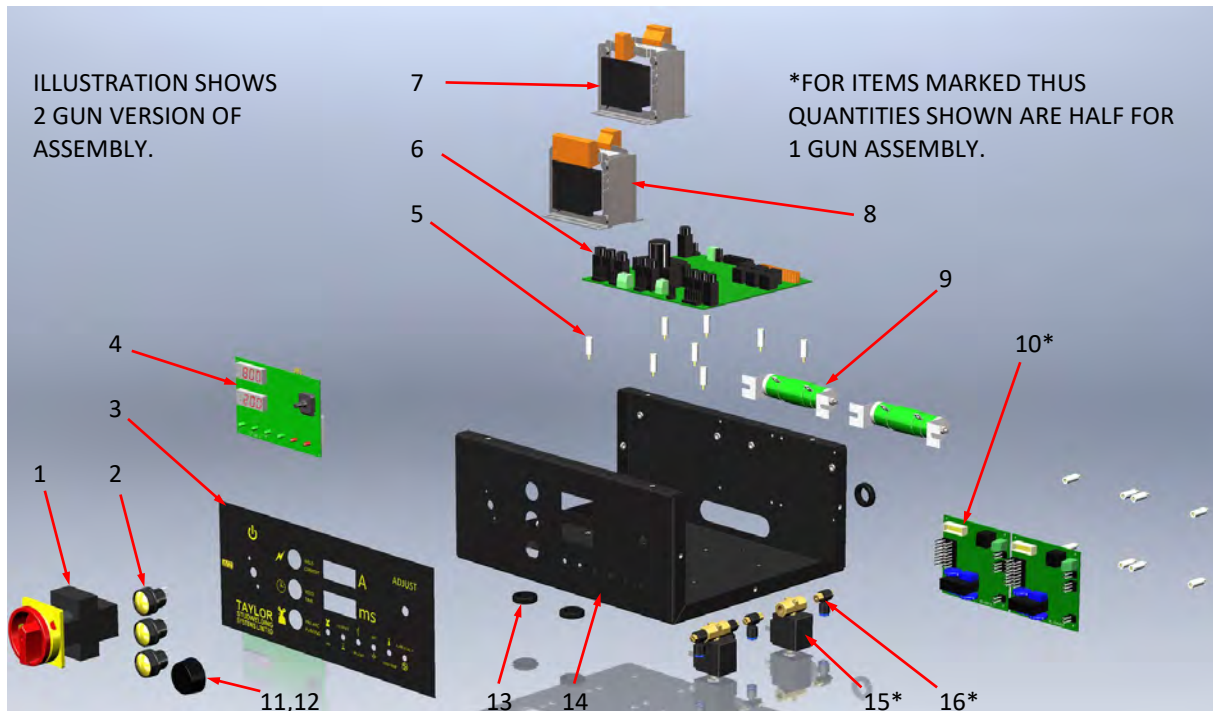

ITEM	QTY.	PART No.	DESCRIPTION
1	1	81-104-066	MAINS ON/OFF SWITCH
2	3	81-120-060	PUSHBUTTON
3	1	81-113-136	PANEL OVERLAY
4	1	81-200-102	DISPLAY PCB
5	16	81-104-083	MOUNTING PILLAR (ONLY 12 REQUIRED FOR 1 GUN)
6	1	81-200-100	MAIN PCB
7	1	81-106-296	AUXILIARY TRANSFORMER
8	1	81-106-295	AUXILIARY TRANSFORMER
9	2	81-106-216	RESISTOR
10	2*	81-200-101	GUN PCB
11	1	81-104-030	KNOB
12	1	81-104-032	KNOB CAP
13	4	81-106-257	GROMMET
14	1	81-113-129	CONTROL BOX
15	2*	81-108-071	VALVE
16	4*	PFE-P06-M5M	FITTING

## **PARTS LIST & EXPLODED DIAGRAM**

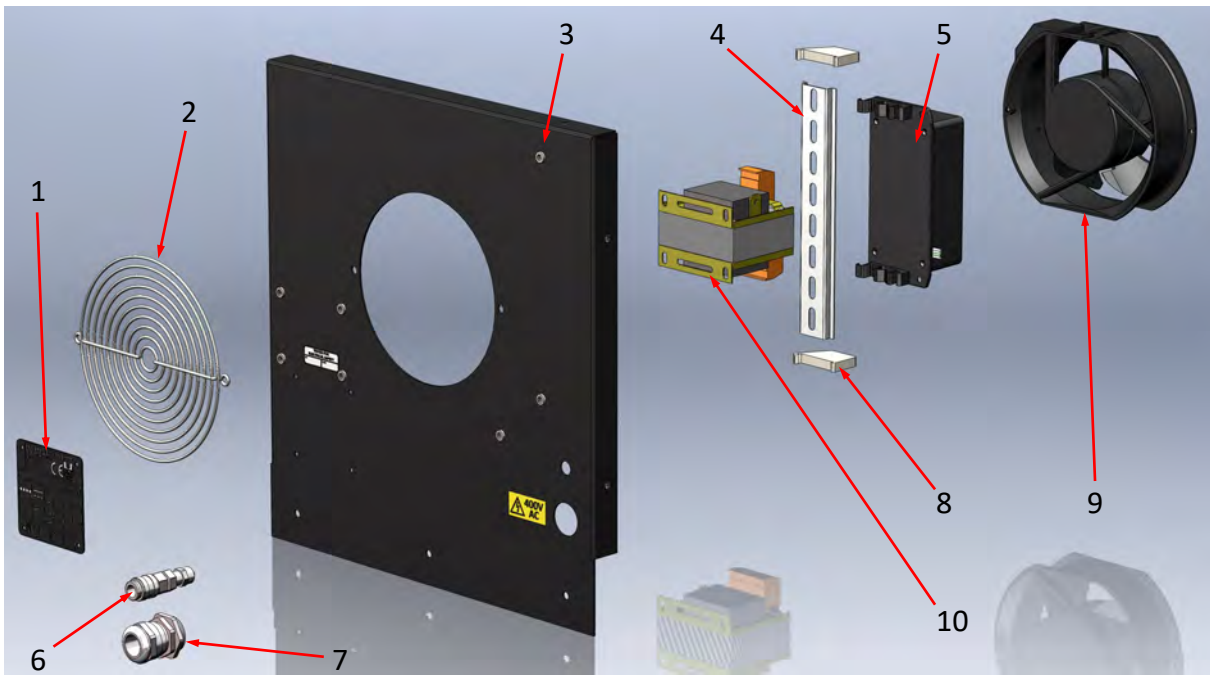

ITEM	No. OFF	PART No.	DESCRIPTION
1	1	81-106-297	SERIAL/DATA LABEL
2	1	81-104-220	FAN GRILLE
3	1	81-113-137	BACK PANEL
4	1	81-106-051	DIN RAIL
5	1	81-106-276	FILTER
6	1	PFX-CSS-B06-BUL	GAS SOCKET
7	1	81-108-019	CABLE GLAND
8	2	81-106-043	RAIL CLAMP
9	1	81-106-081	FAN
10	1	81-113-032	AUXILIARY TRANSFORMER

ITEMS NOT SHOWN & MAINS PLUGS AVAILABLE FROM STOCK

ITEM	No. OFF	PART No.	DESCRIPTION
1	1	81-113-142	WIRING HARNESS - MAIN LOOM
2	1	81-113-143	WIRING HARNESS - SECONDARY LOOM
3	4	71-300-008	MAINS FLEXIBLE CABLE (per metre)

ITEM	No. OFF	PART No.	DESCRIPTION
1	1	81-108-066	3 PHASE, 380/415V AC, 32A, 4 PIN
2	1	81-108-073	3 PHASE, 380/415V AC, 32A, 5 PIN

# PCB's - LED GUIDE (see page 9 for display PCB LED's)

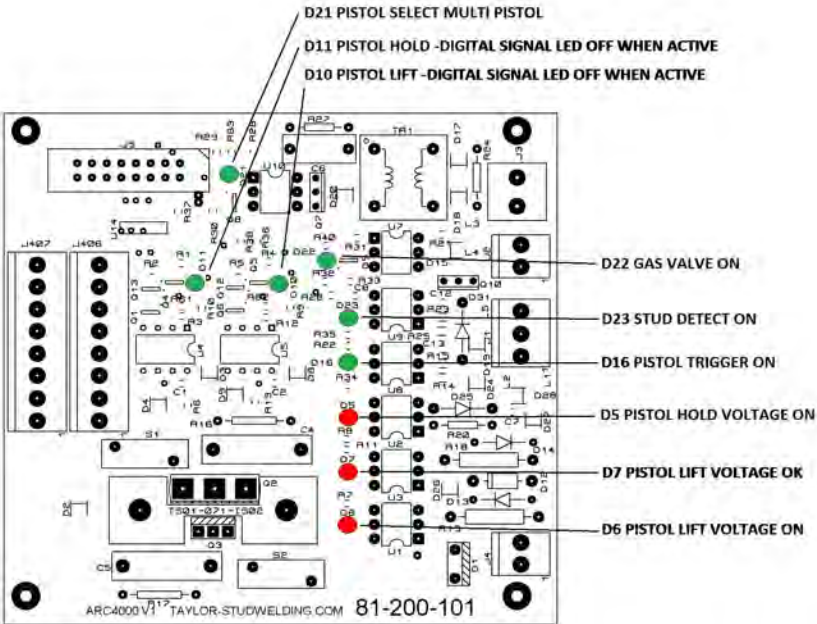
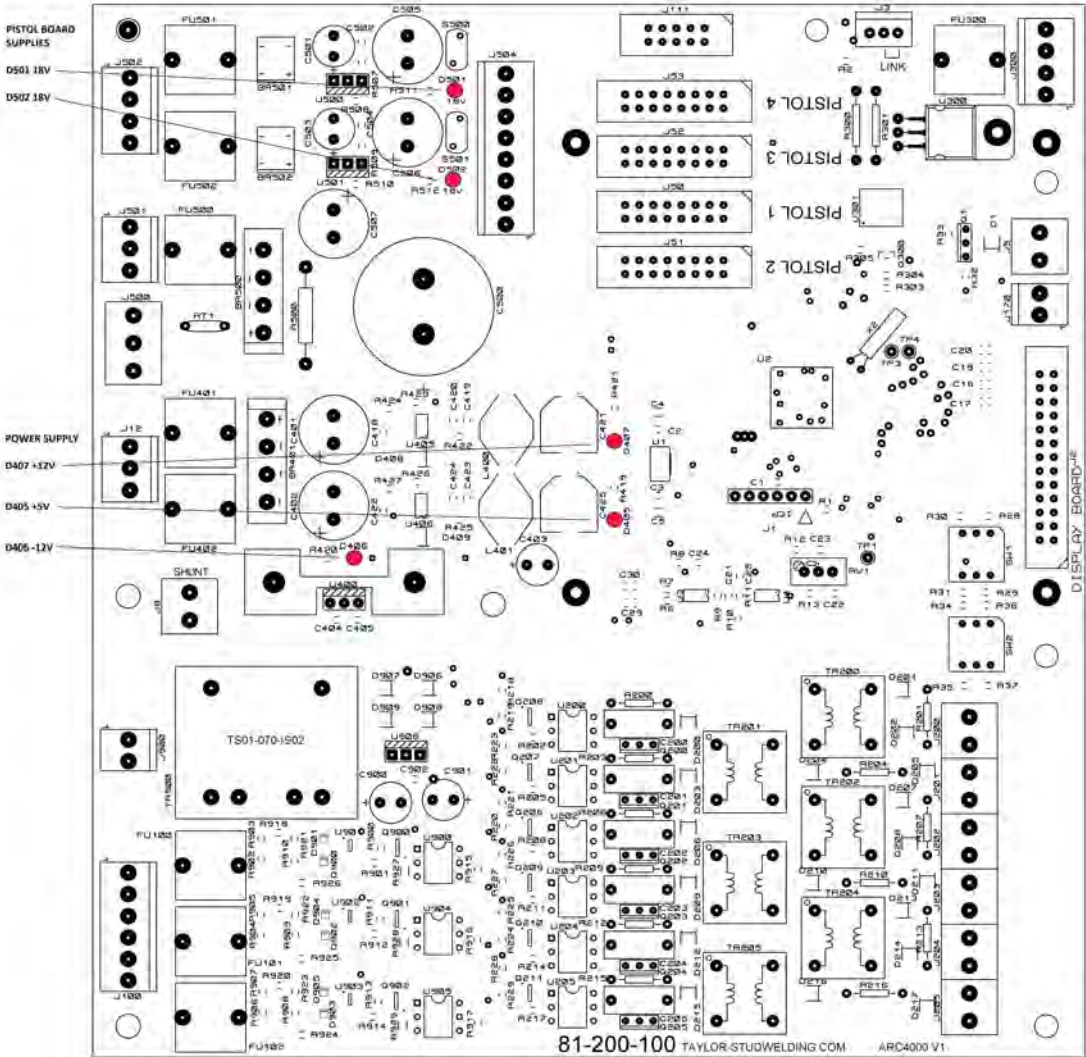

# CIRCUIT SCHEMATIC

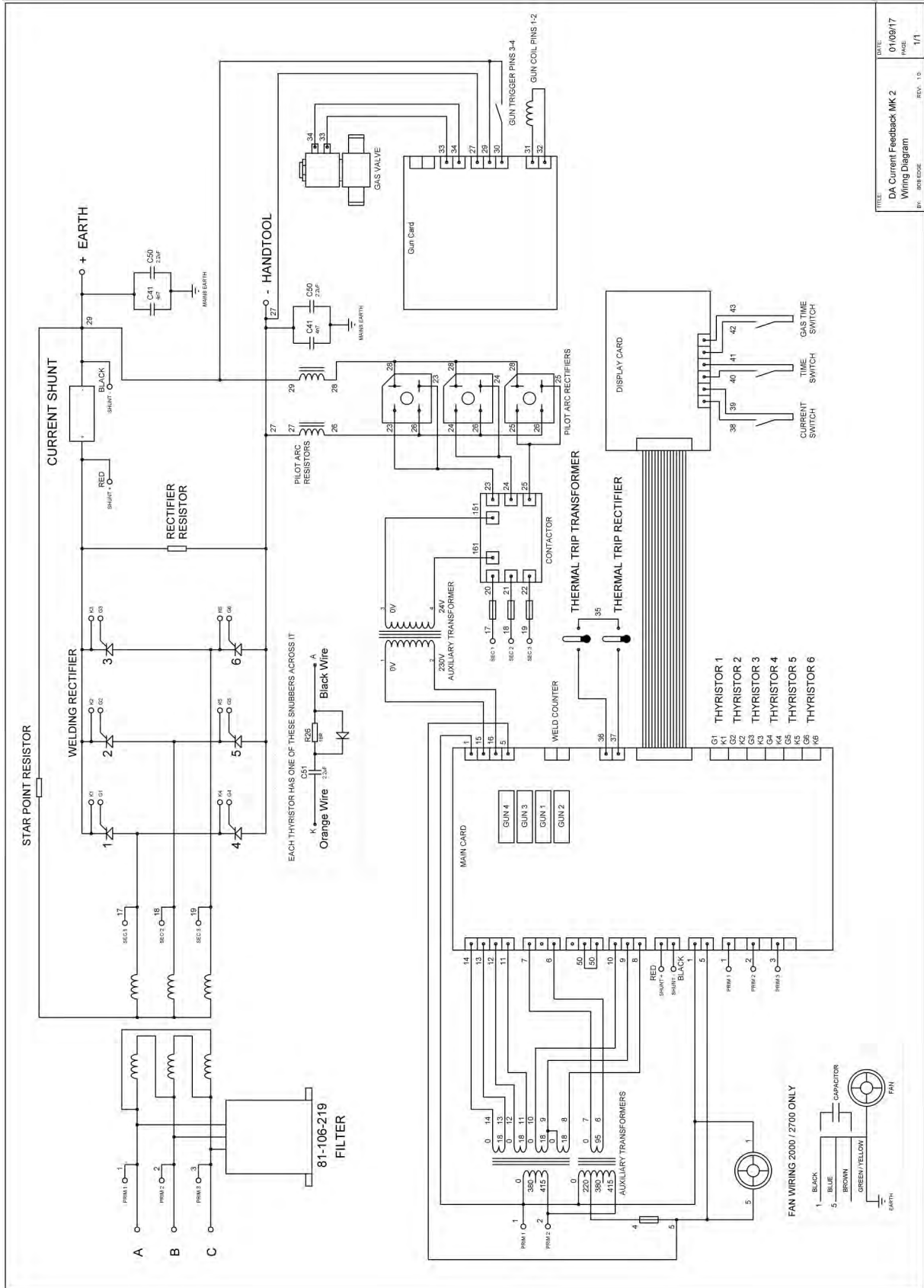

TITLE	DA Current Feedback MK 2
DATE	01/09/17
BY	JBH/BJE
REV. 1.0	
PAGE	1/1
REV. 1.0	

## **ACCESSORIES**

Both the earth connection sockets on the controller are bussed on the same internal bus-bar. It is possible to weld with only one earth connection but where possible connect 2 earth cables to every workpiece (see page 11. Setting up and Welding) as this gives better results. An earth cable must be connected to the controller in this user guide. A pair of cables comprises 2 off the standard cable assembly part number listed below.

STANDARD EARTH CABLE ASSEMBLY FOR SYSTEM 800

**99-101-090**

Spare parts for the maintenance of earth cables are listed below:

WELD PLUG	81-101-051
CABLE/m	71-300-004
EARTH CLAMP	81-101-135
CRIMP TERMINAL	Z700-08-060



# EU DECLARATION OF CONFORMITY

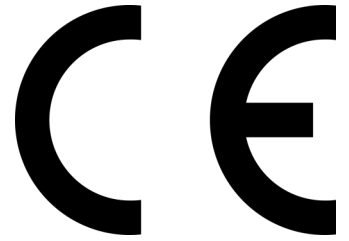

Responsible Party Name : Taylor Studwelding Systems Ltd  
Address : Commercial Road  
Dewsbury  
West Yorkshire  
WF13 2BD  
UK

Designation of Product : Studwelding equipment ARC4000 series. Model 800E  
Studwelding gun series DA2-A to DA20

The above mentioned equipment complies with the requirements of the following directives :

<b>93/68/EEC</b>	<b>The CE Marking Directive</b>
<b>2014/35/EU</b>	<b>The Low Voltage Directive</b>
<b>2014/30/EU</b>	<b>The Electromagnetic Compatibility Directive</b>

The above mentioned products conform to the following European standards :

<b>EN 60974-1:2012</b>	<b>ARC WELDING EQUIPMENT - PART 1 : WELDING POWER SOURCES</b>
<b>EN60974-10:2014</b>	<b>ARC WELDING EQUIPMENT - PART 10 : ELECTROMAGNETIC COMPATIBILITY (EMC) REQUIREMENTS</b>

I hereby declare that the above mentioned equipment has been designed to comply with the relevant sections of the above referenced standards. The equipment complies with all applicable essential requirements of the above mentioned directives.

Signed.

David Taylor  
Managing Director



Authorised European Representative : **J D PEARMAN**  
**GLENN MILLERWEG 36**  
**1311 RT ALMERE**  
**NETHERLANDS**